

# La fourmi sur la caisse

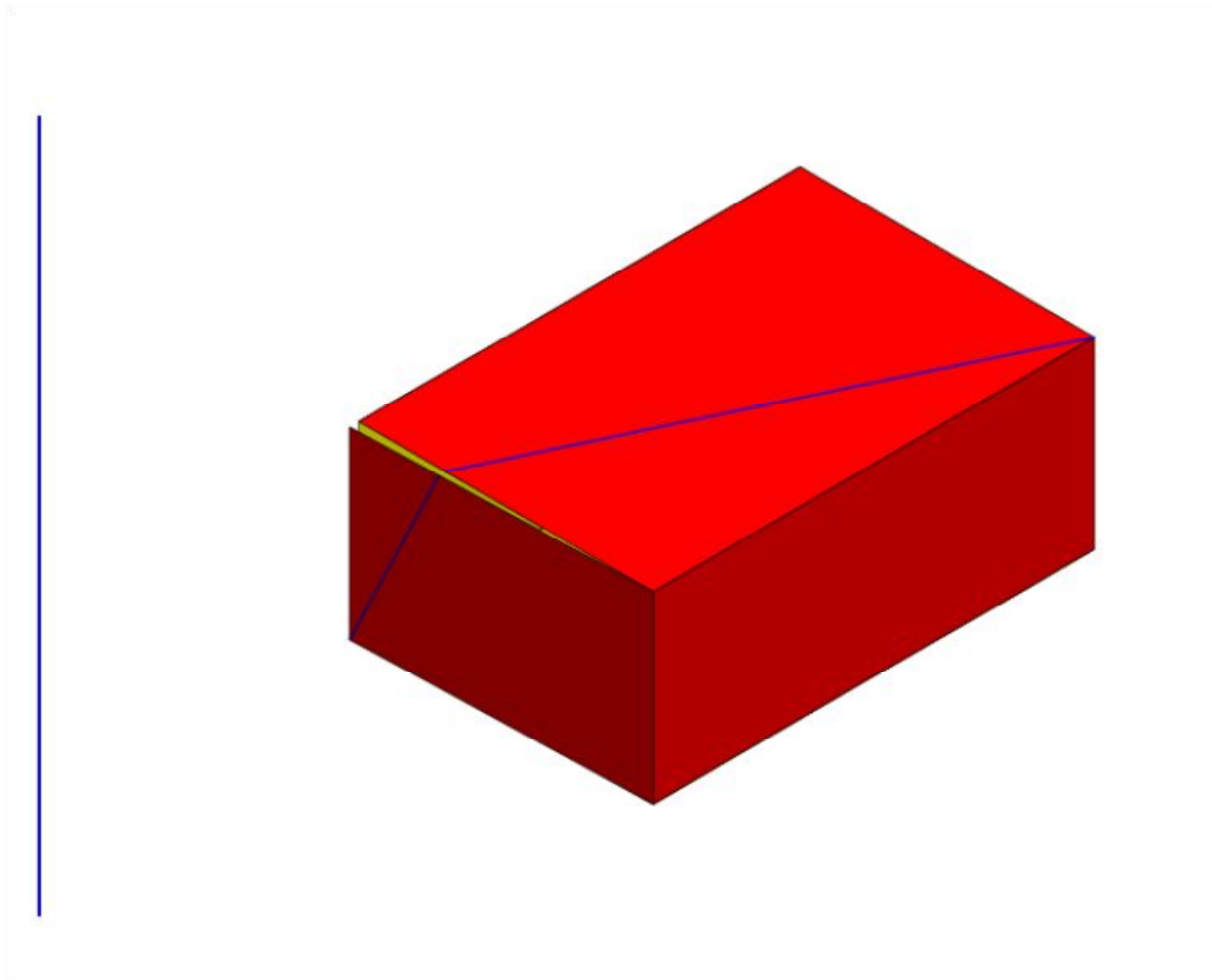

# La fourmi sur la caisse

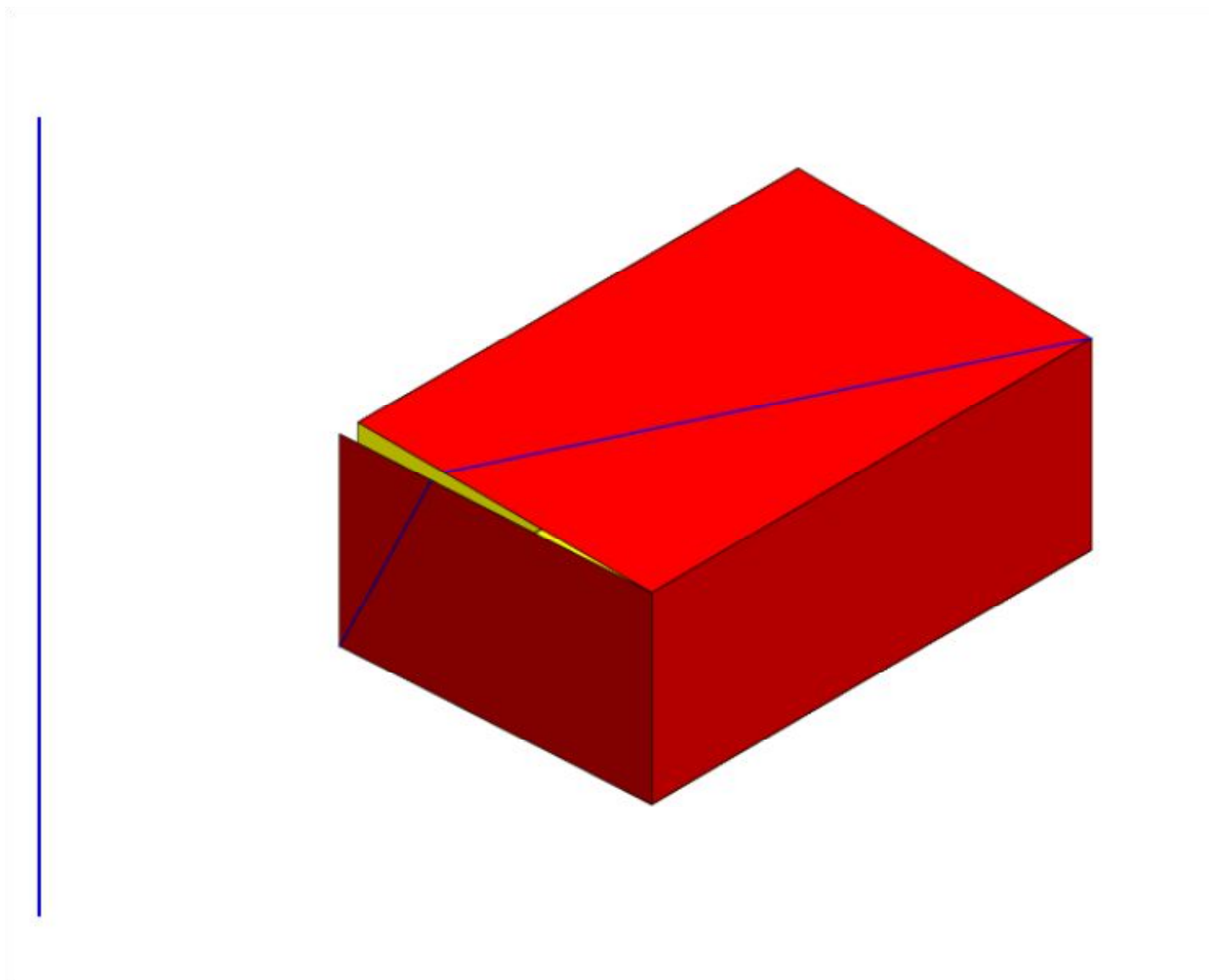

# La fourmi sur la caisse

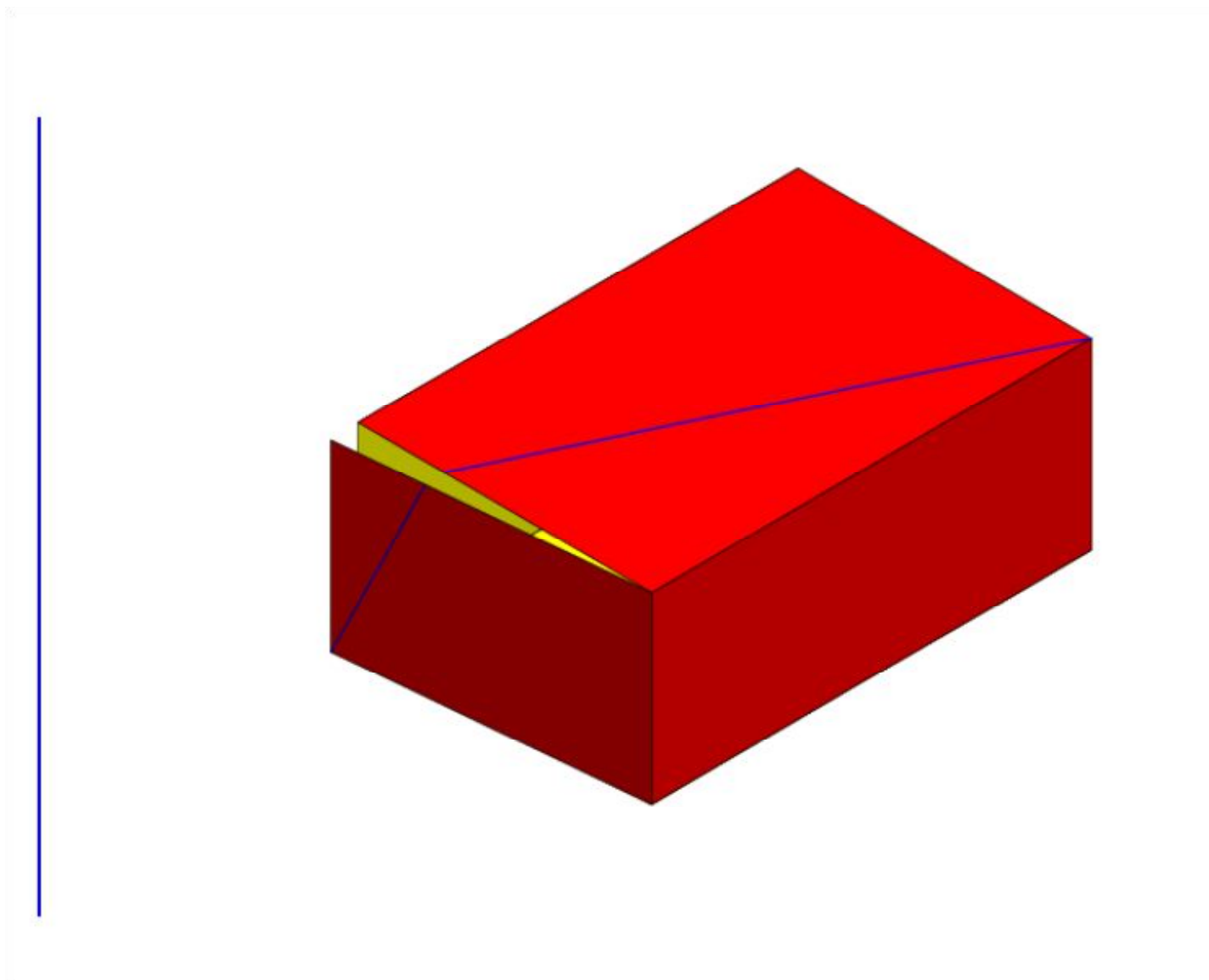

# La fourmi sur la caisse

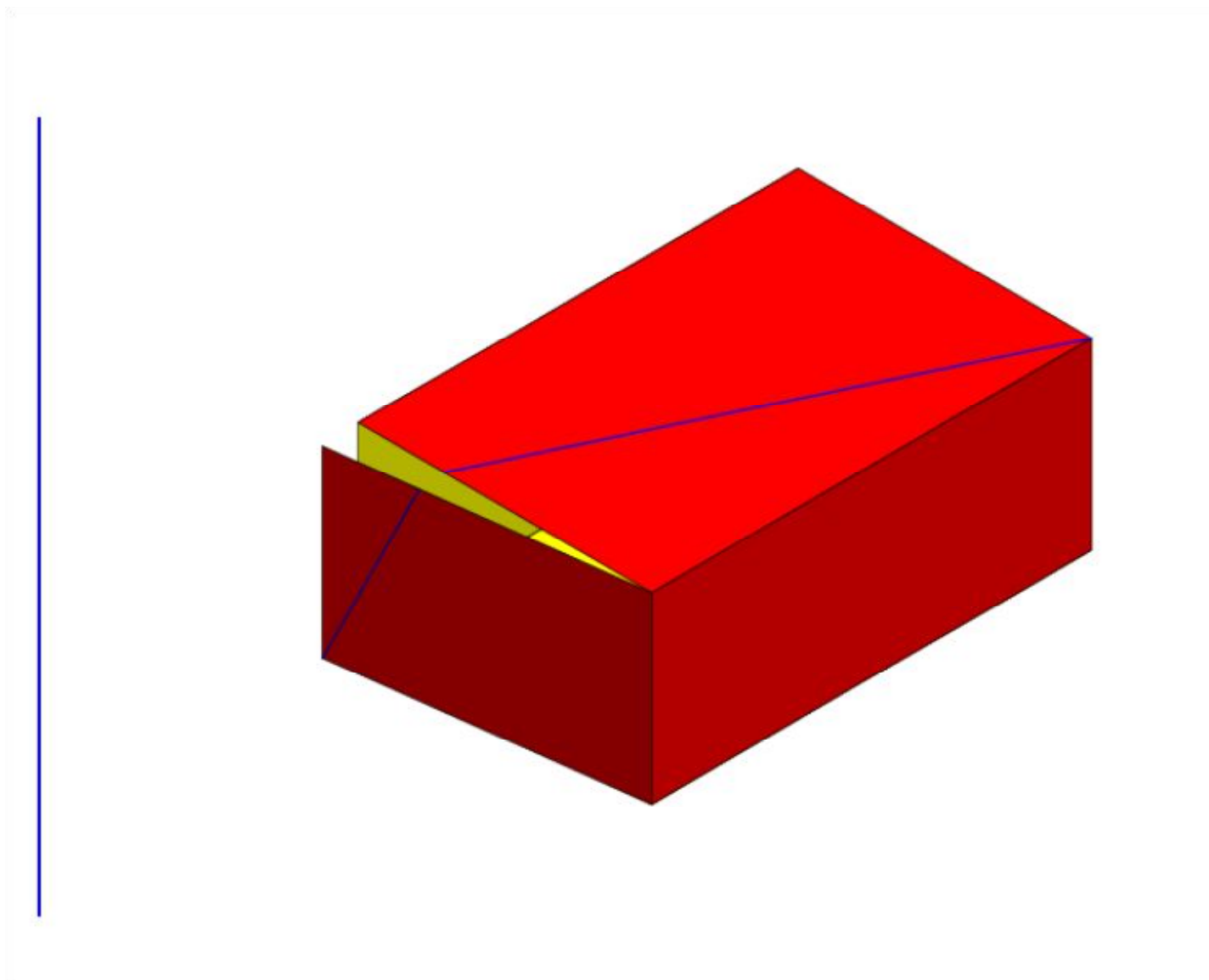

# La fourmi sur la caisse

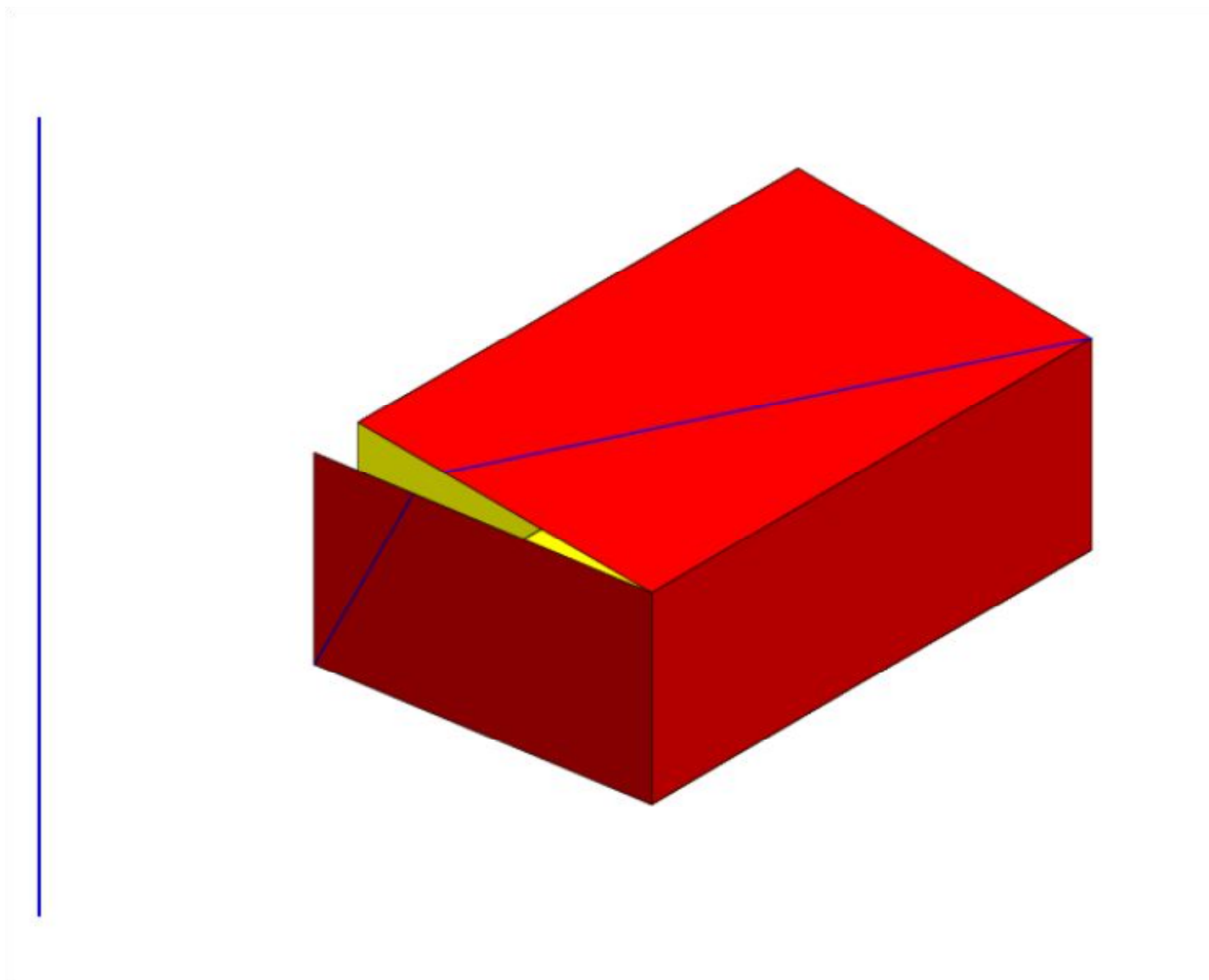

# La fourmi sur la caisse

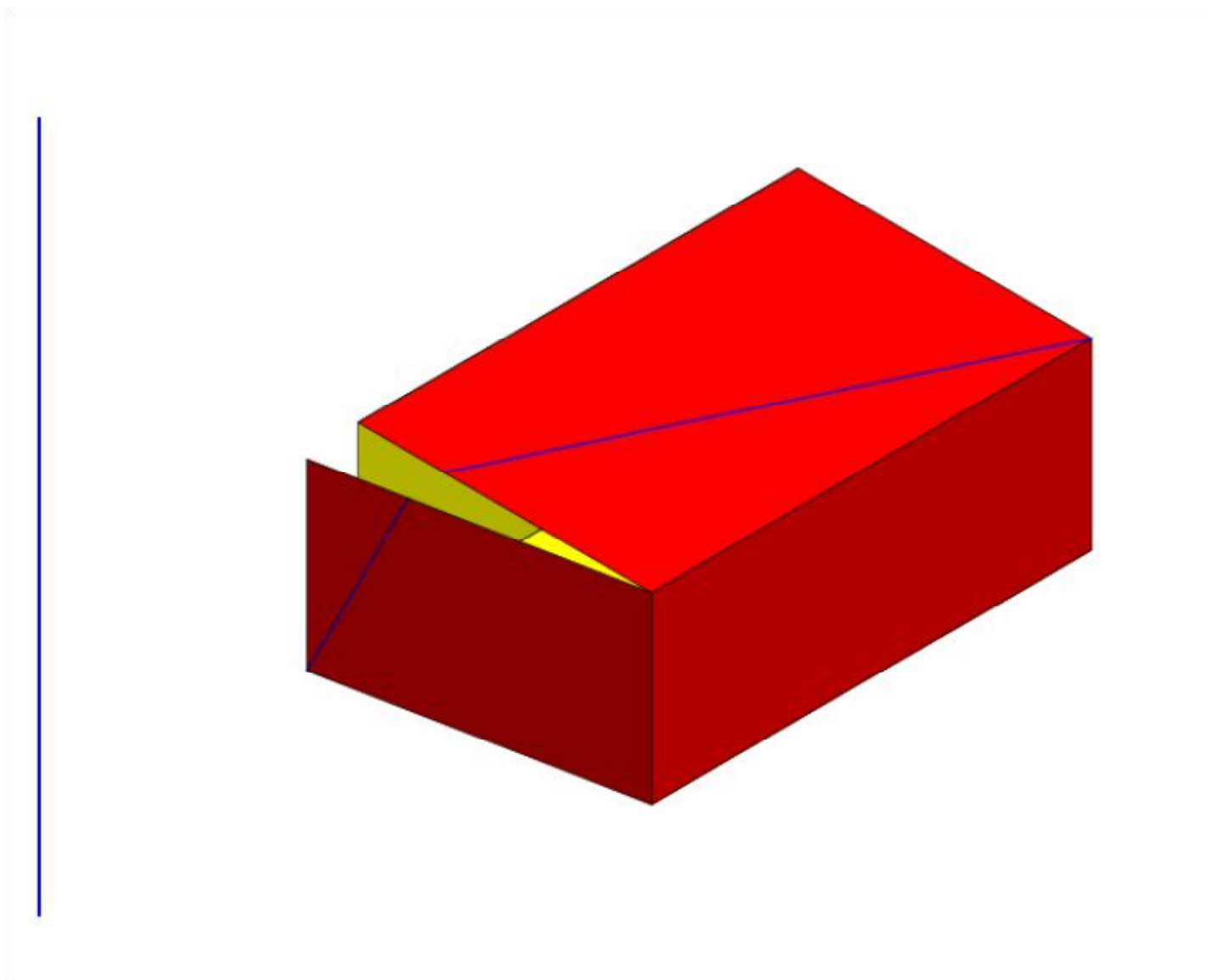

# La fourmi sur la caisse

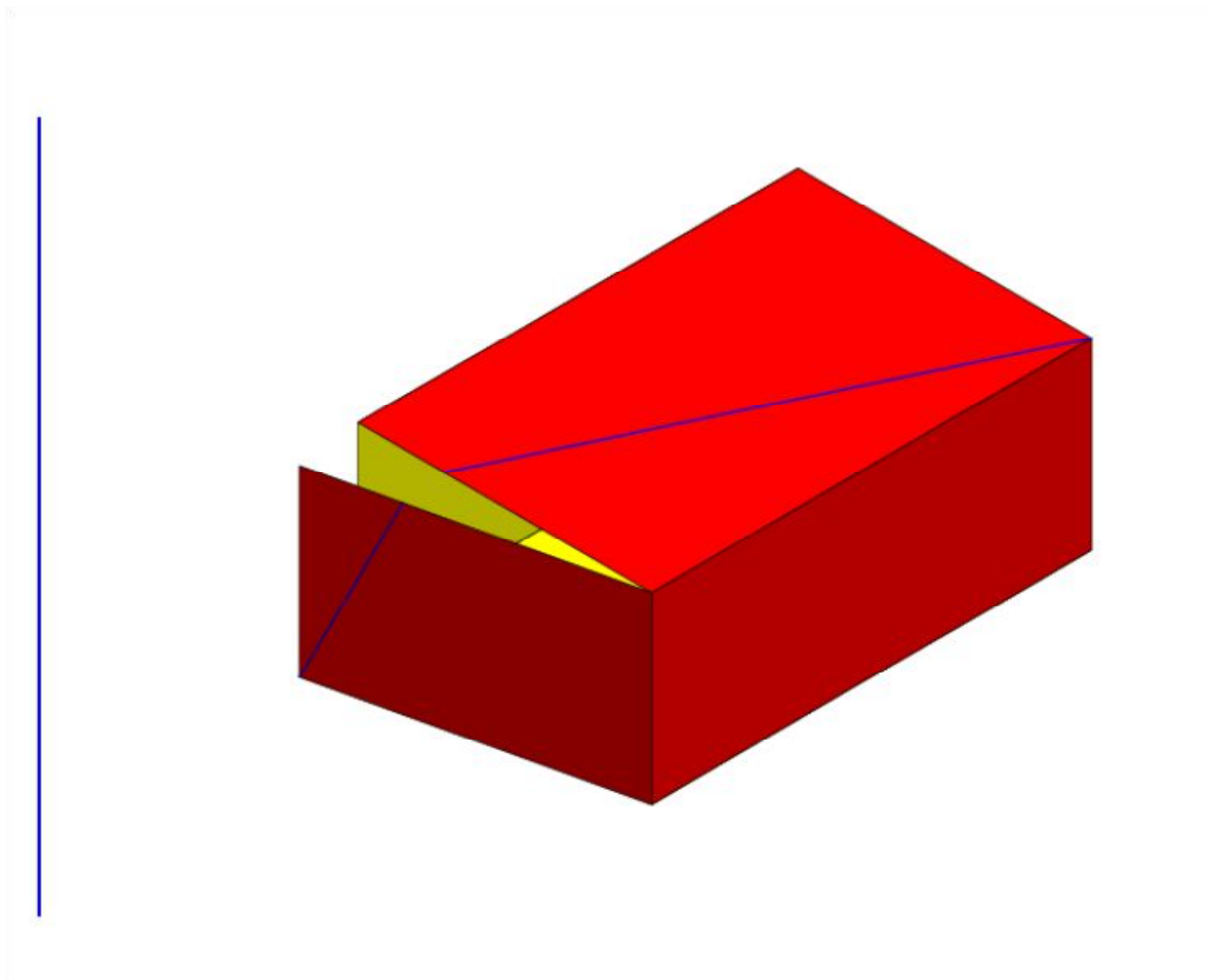

# La fourmi sur la caisse

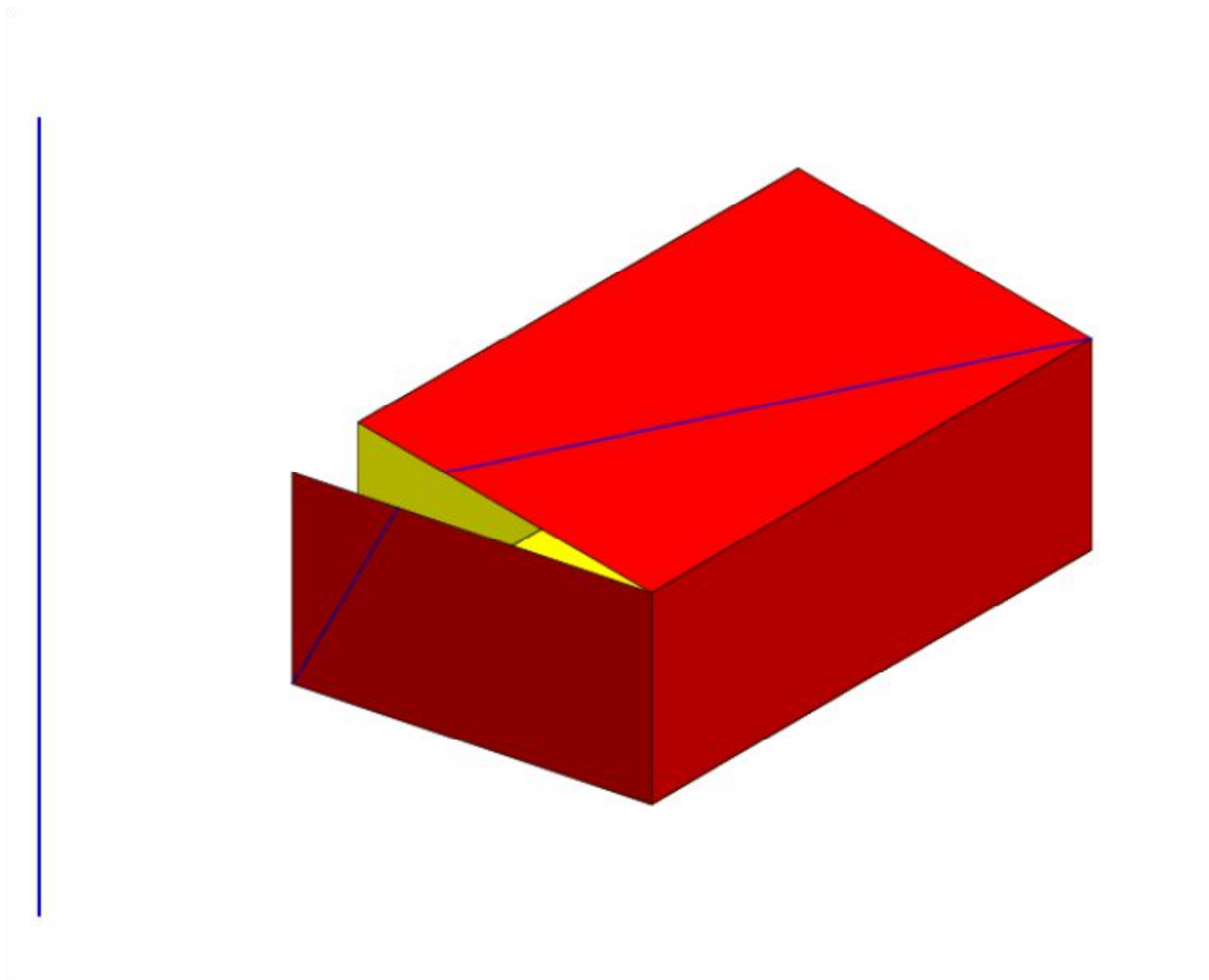



# La fourmi sur la caisse

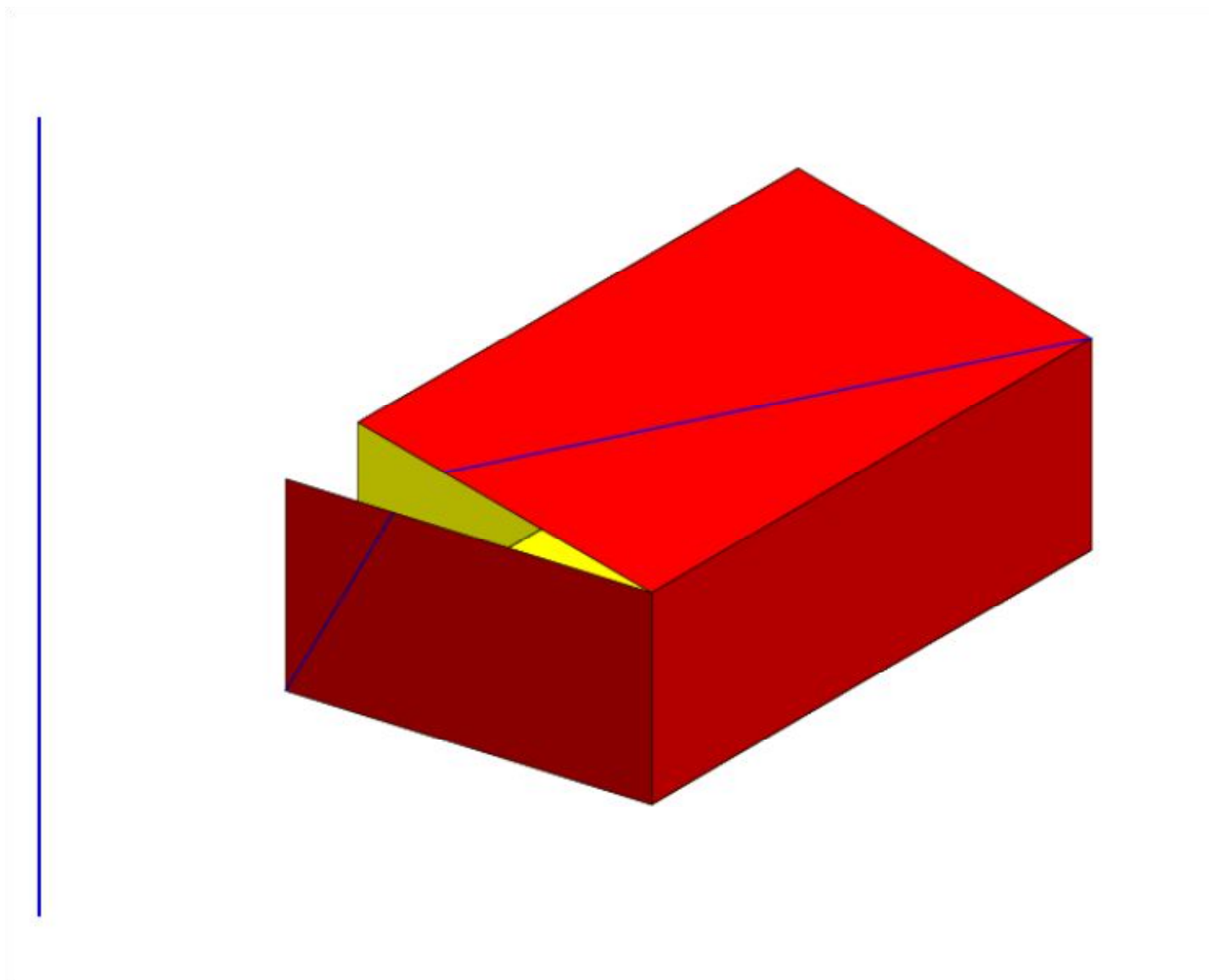

# La fourmi sur la caisse

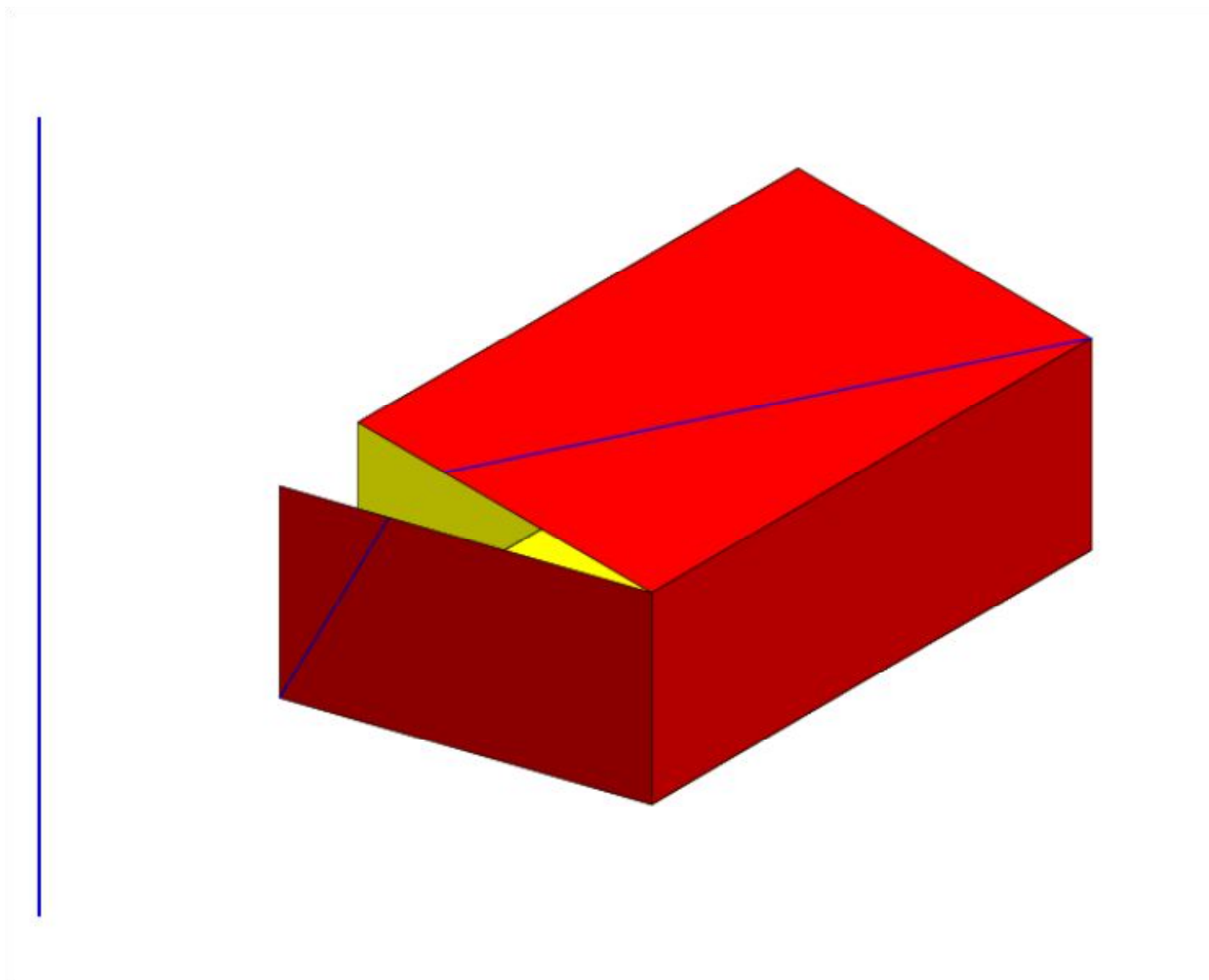

# La fourmi sur la caisse

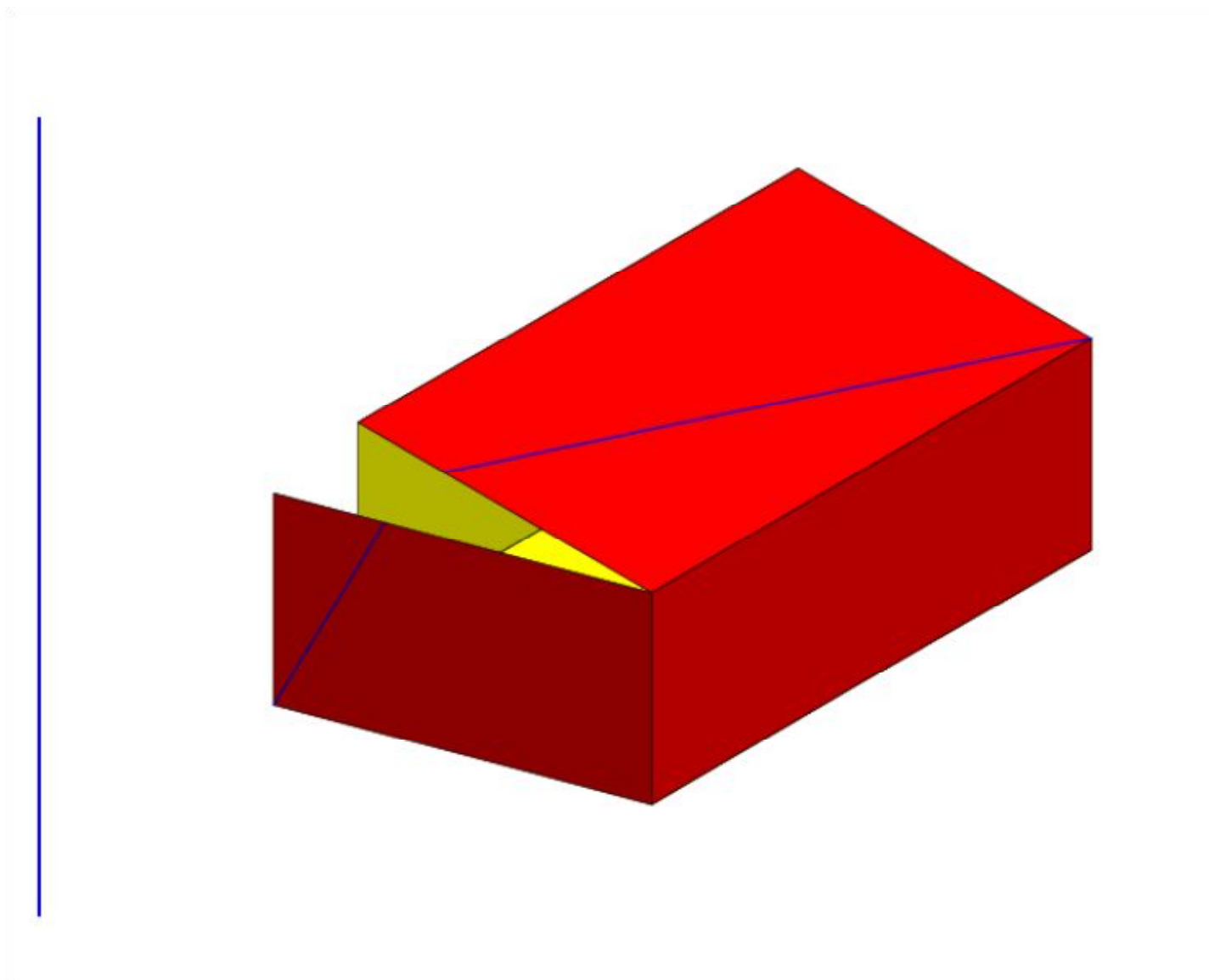

# La fourmi sur la caisse

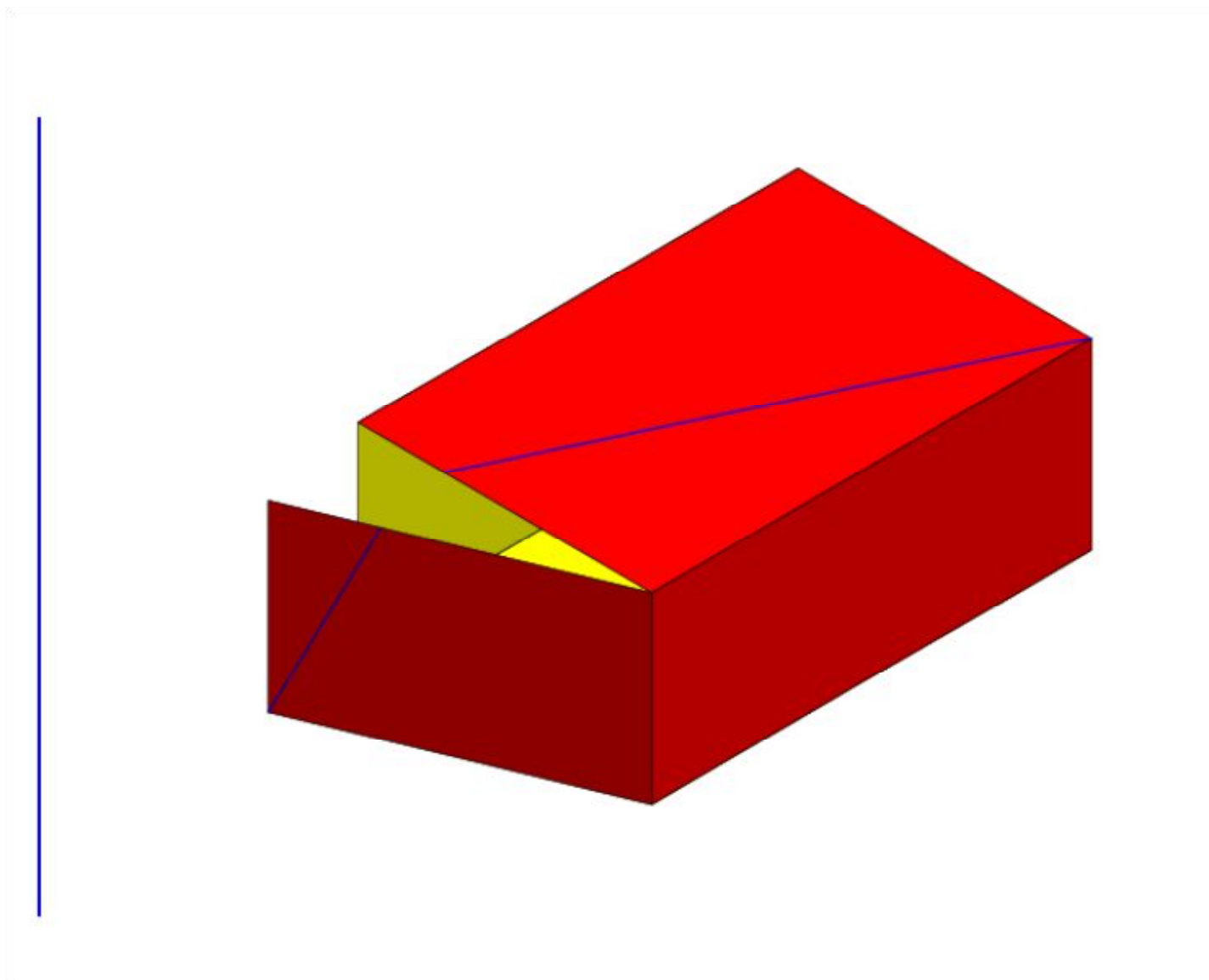

# La fourmi sur la caisse

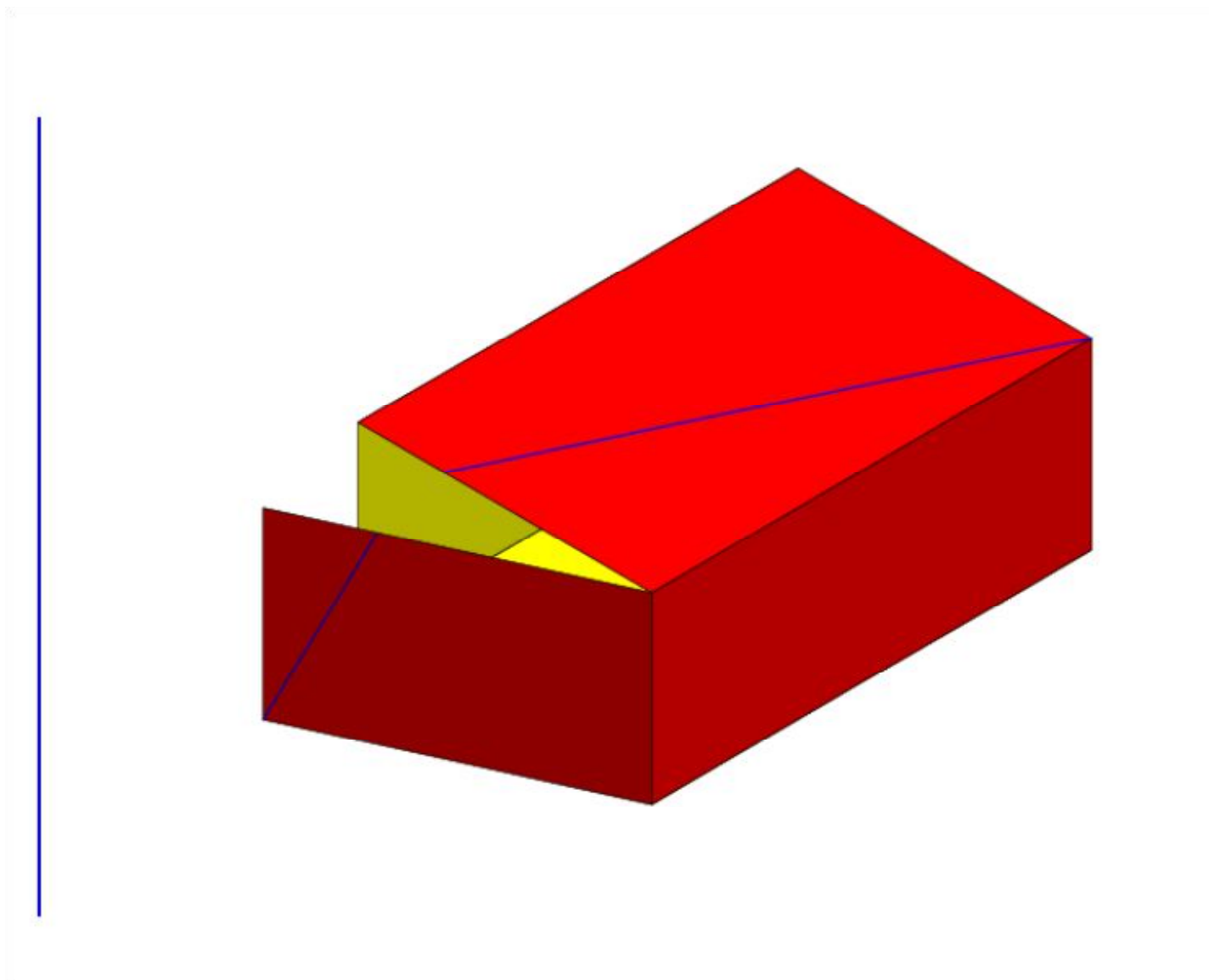

# La fourmi sur la caisse

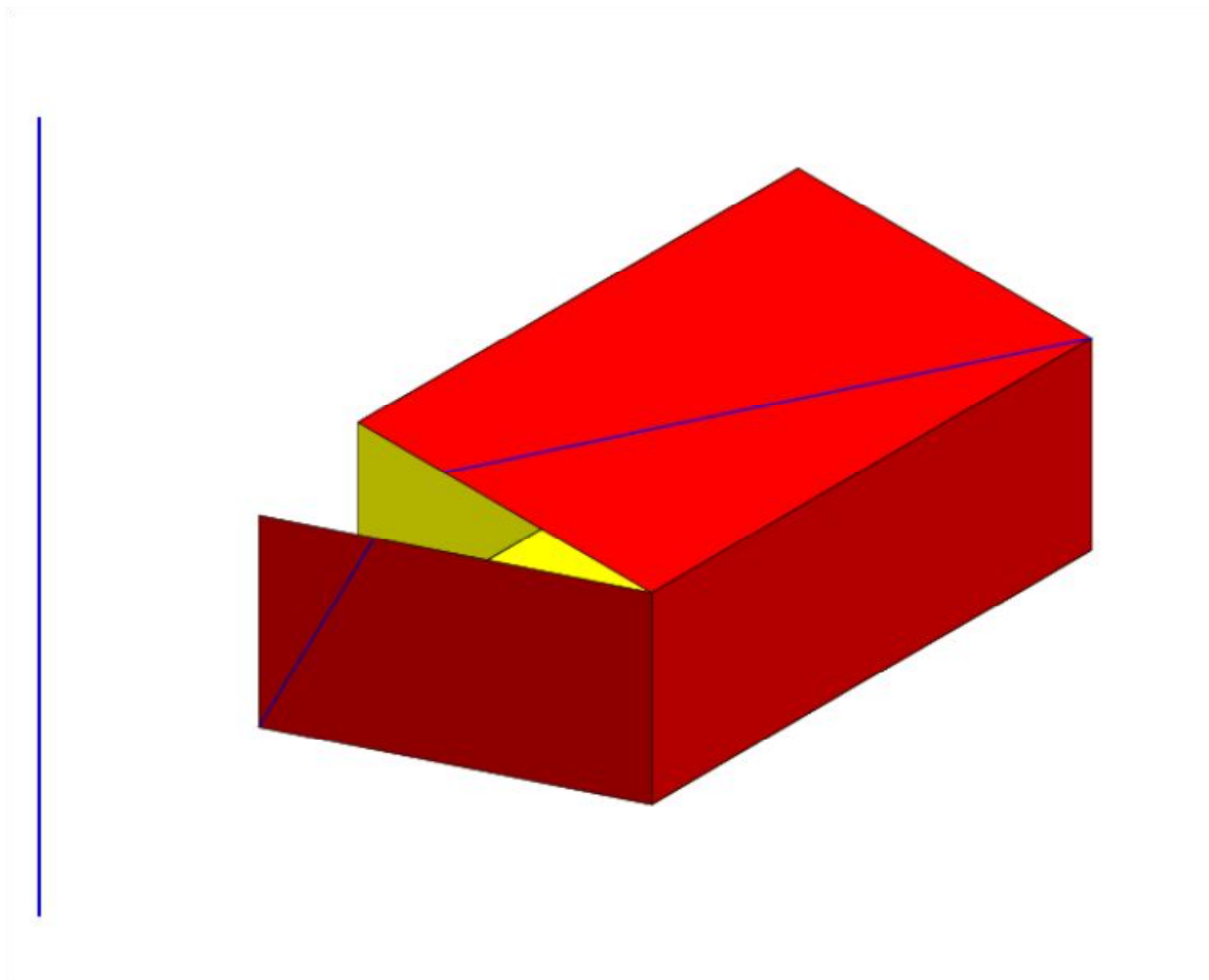

# La fourmi sur la caisse

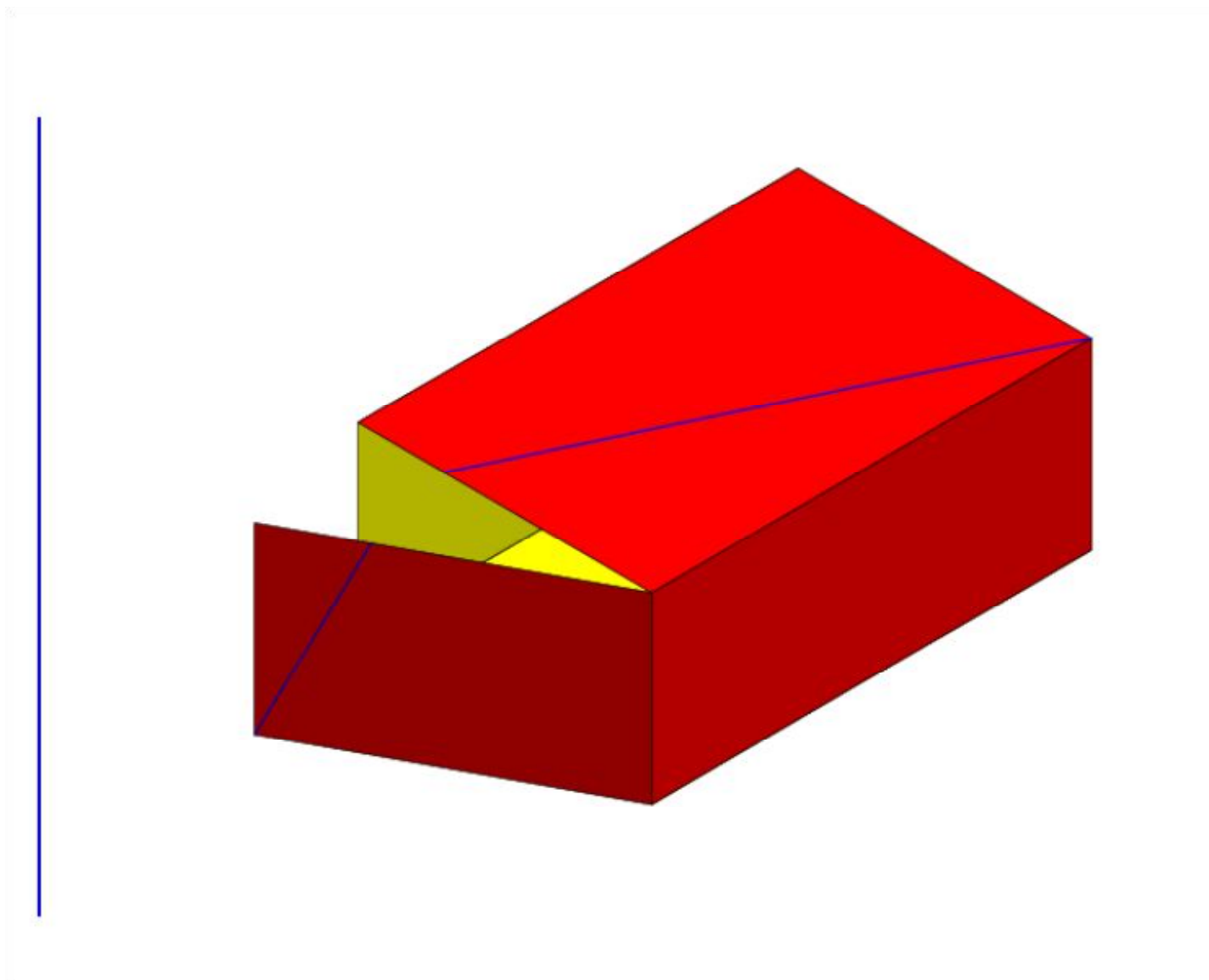

# La fourmi sur la caisse

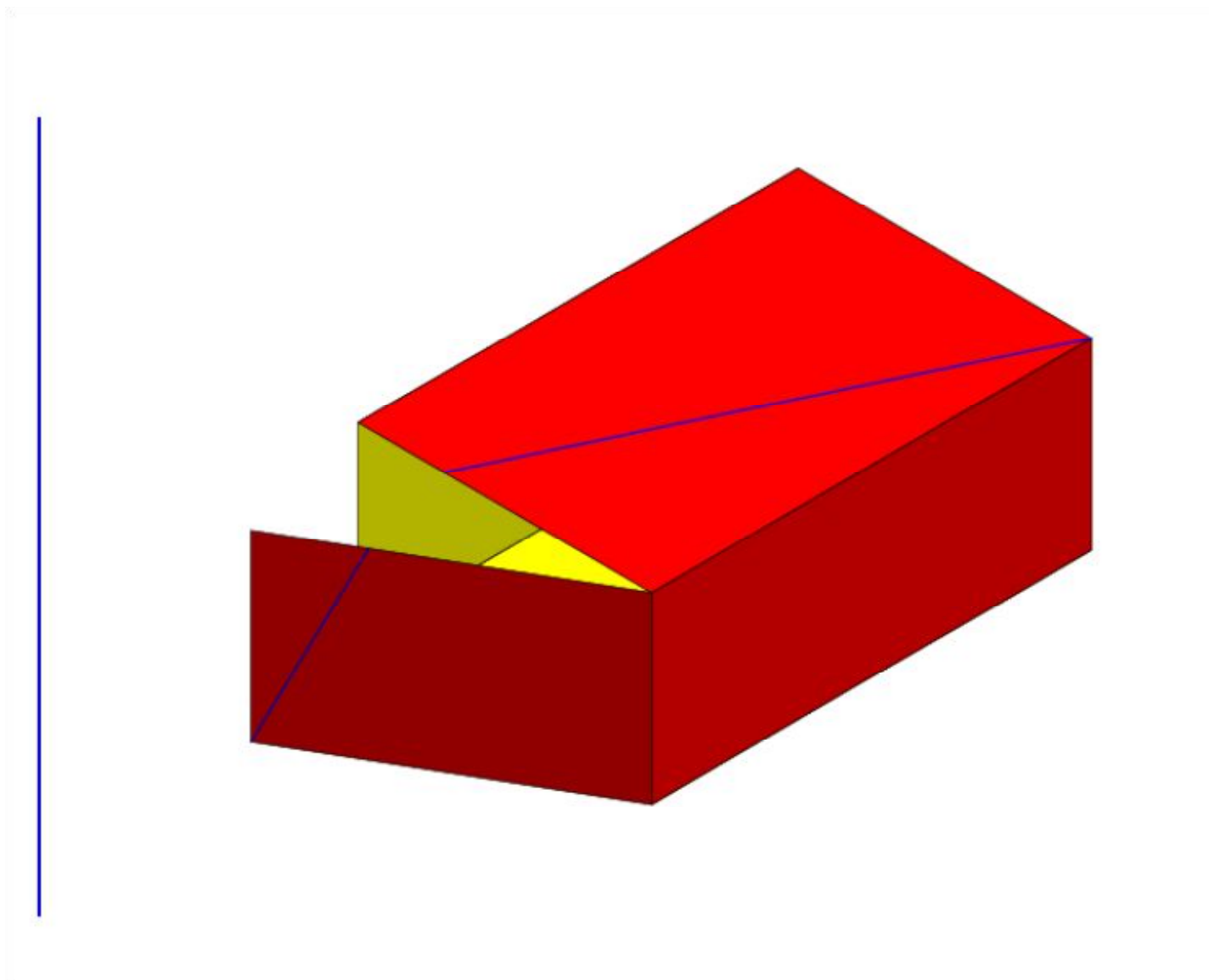



# La fourmi sur la caisse

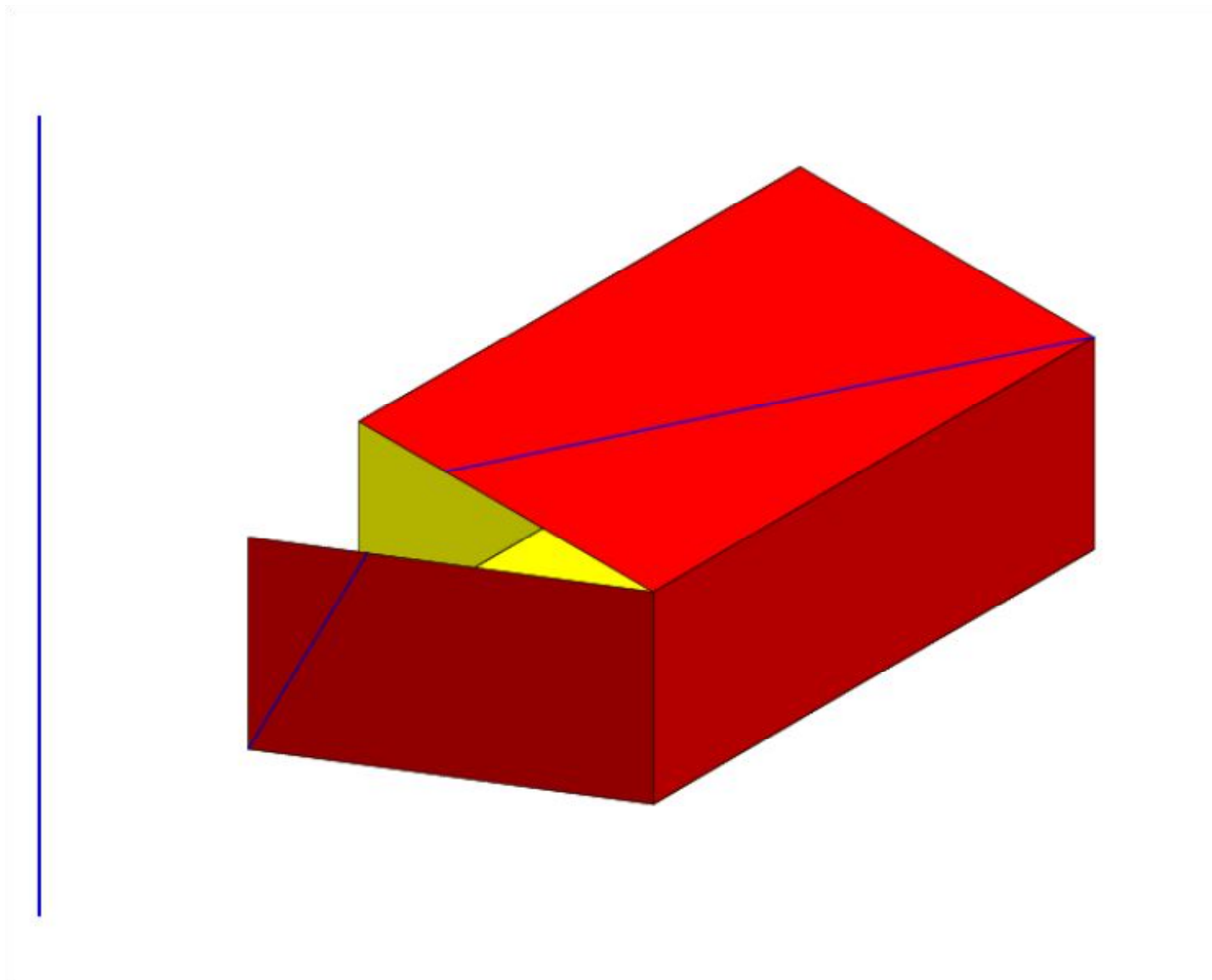

# La fourmi sur la caisse

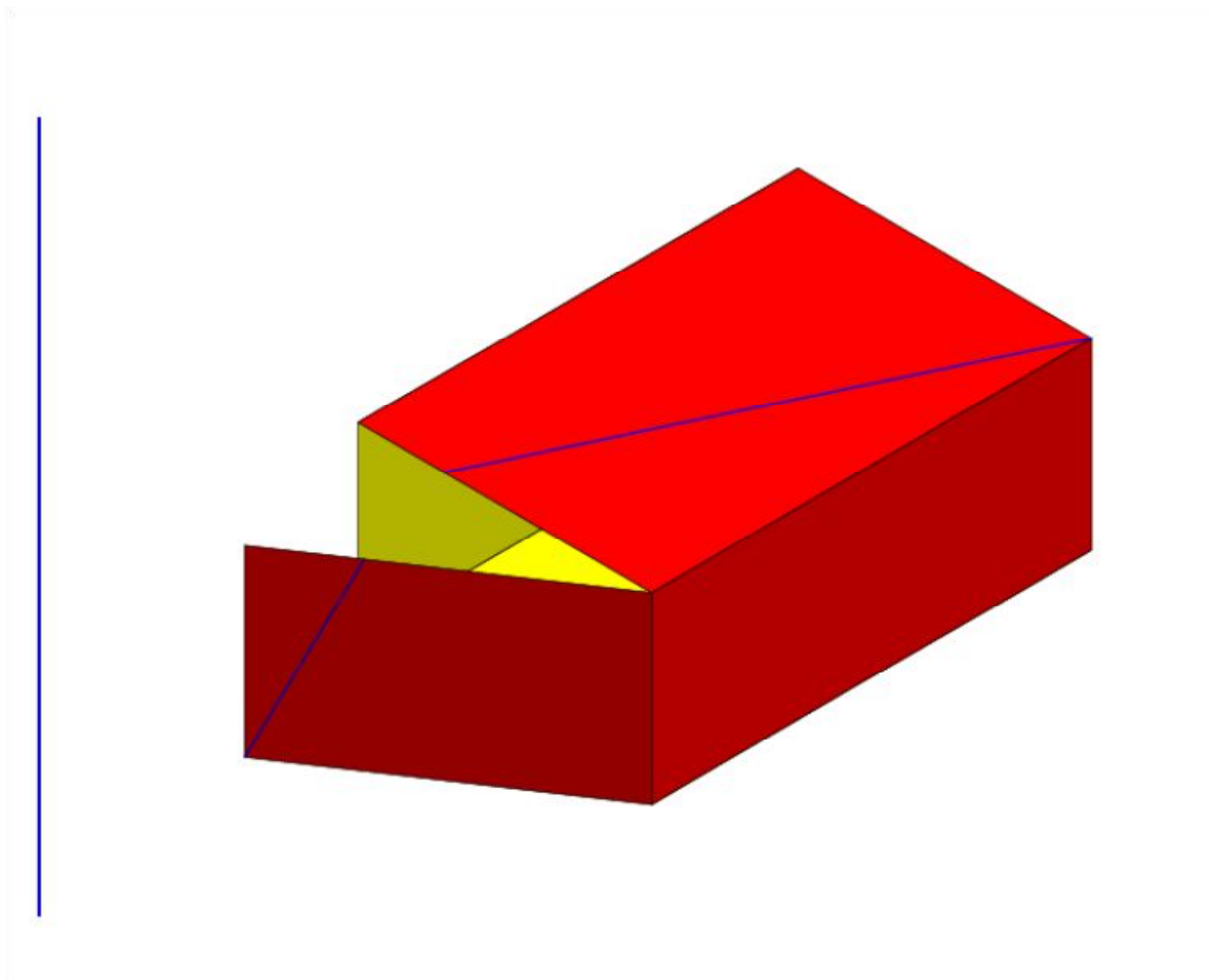

# La fourmi sur la caisse

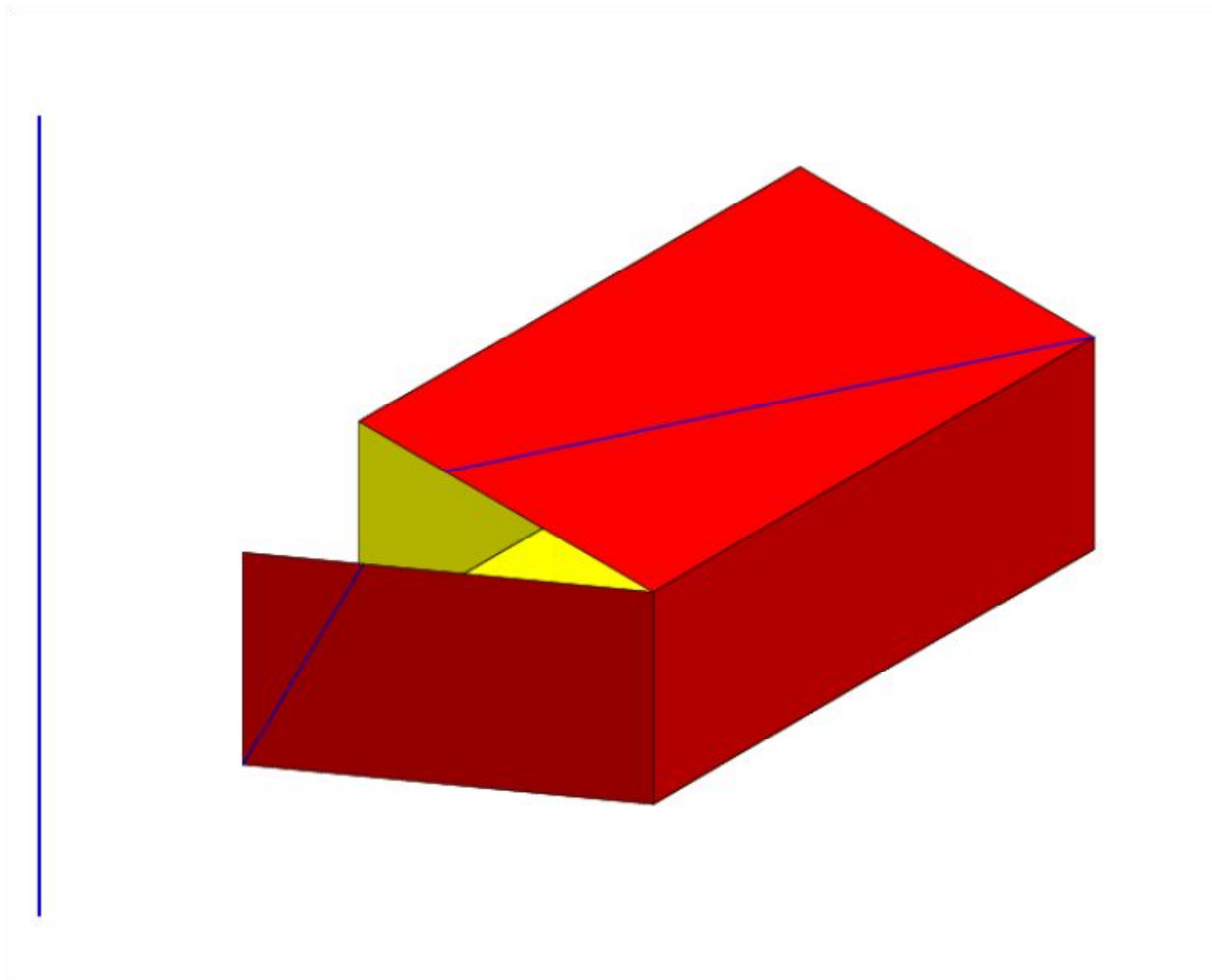

# La fourmi sur la caisse

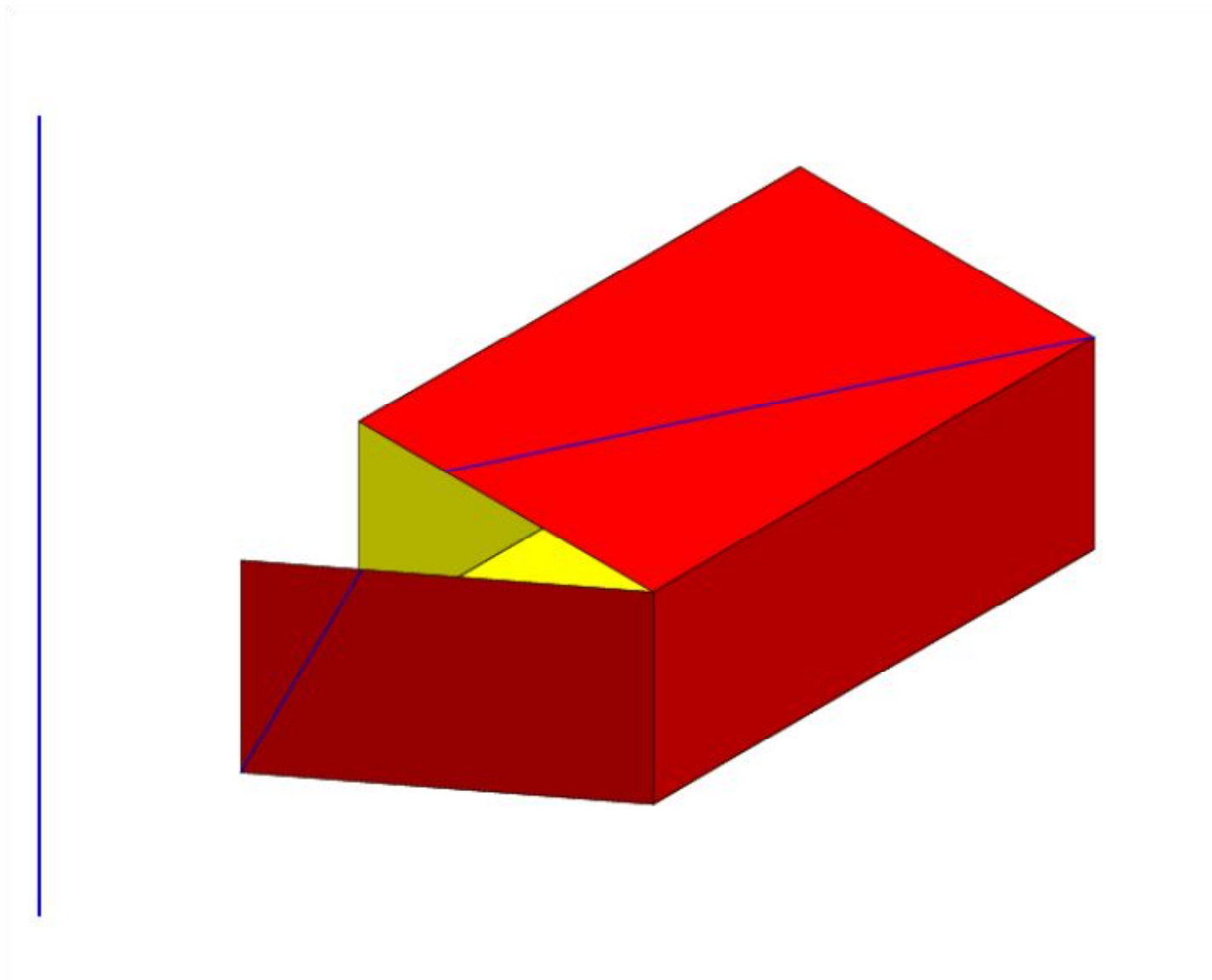

# La fourmi sur la caisse

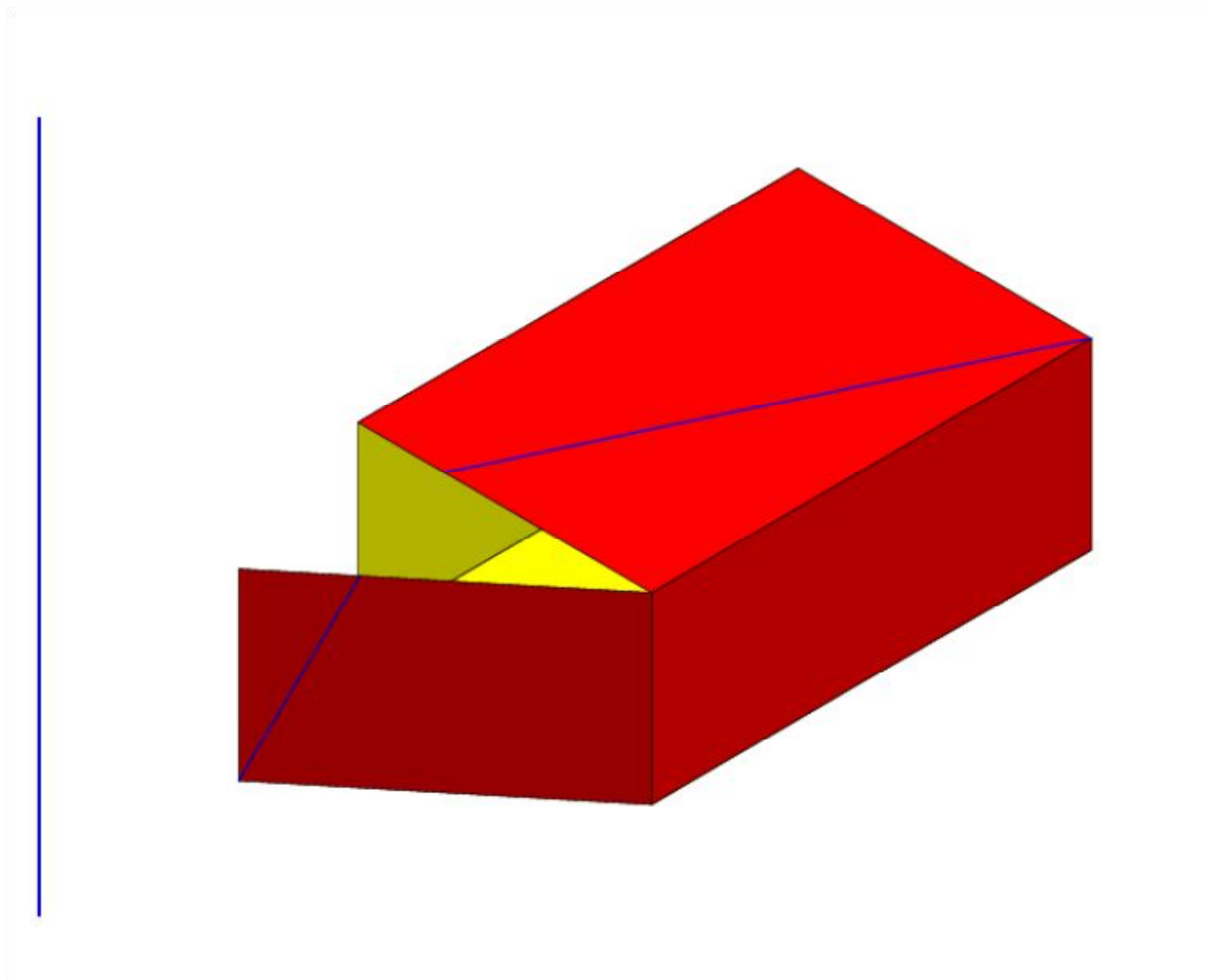

# La fourmi sur la caisse

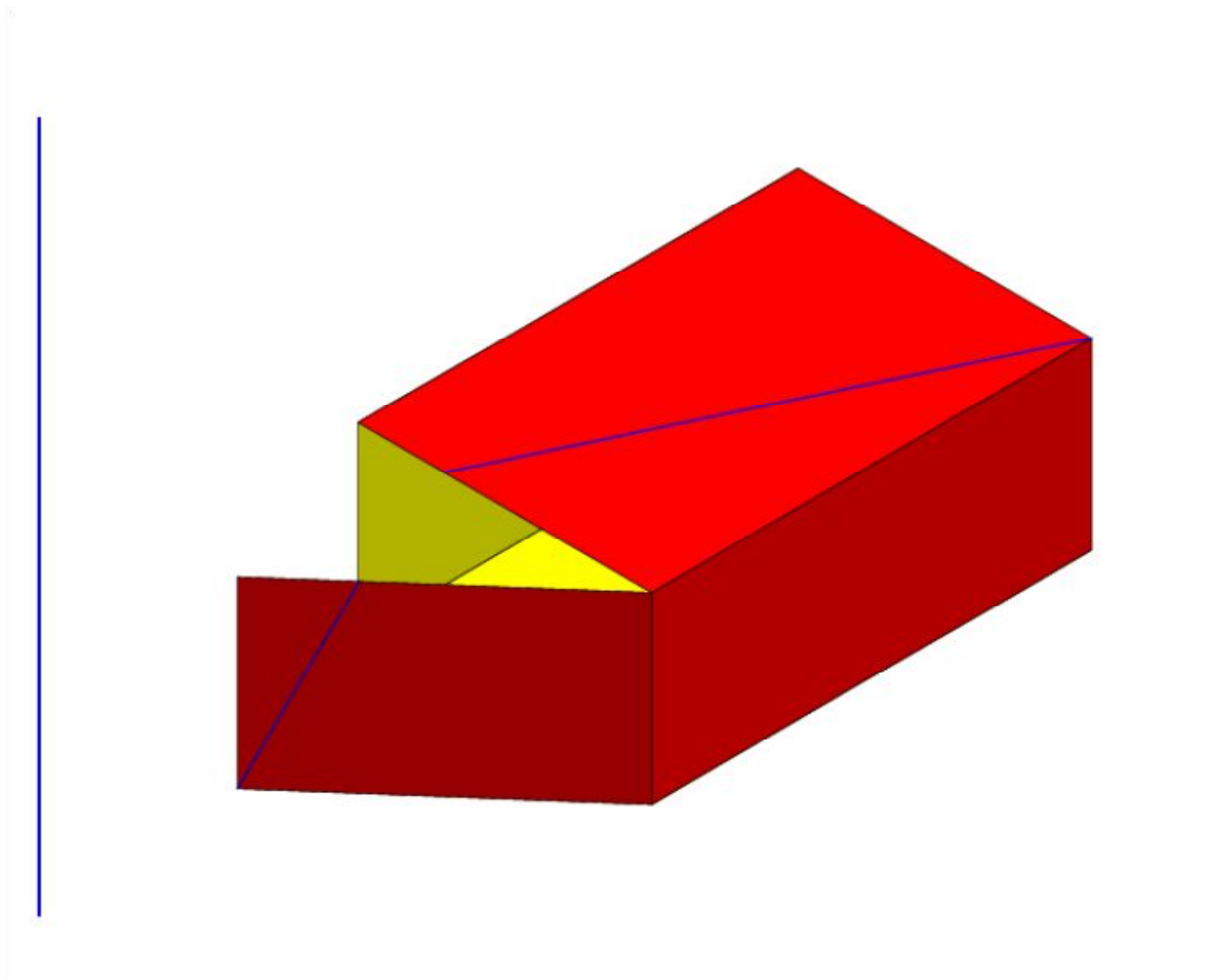

# La fourmi sur la caisse

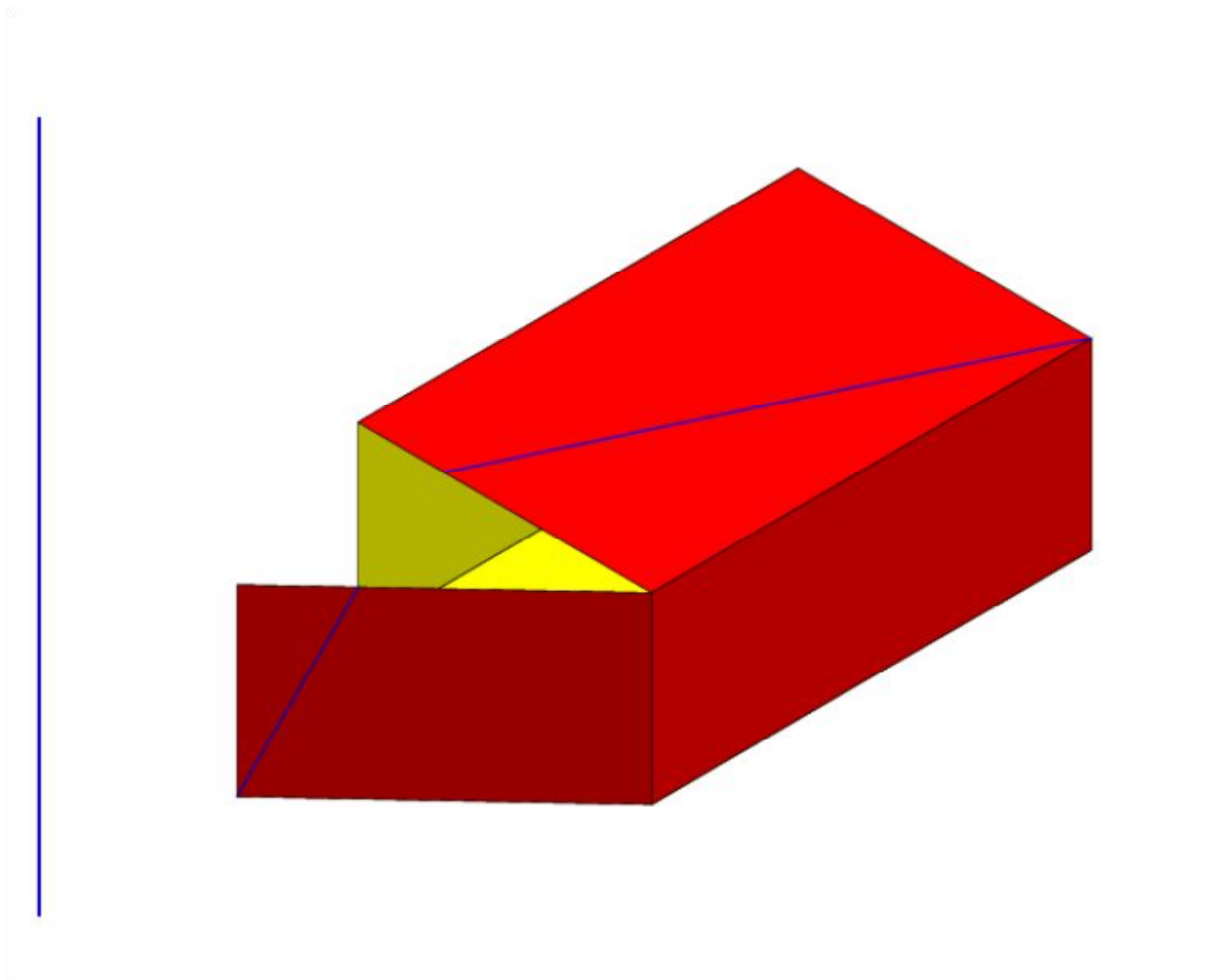

# La fourmi sur la caisse

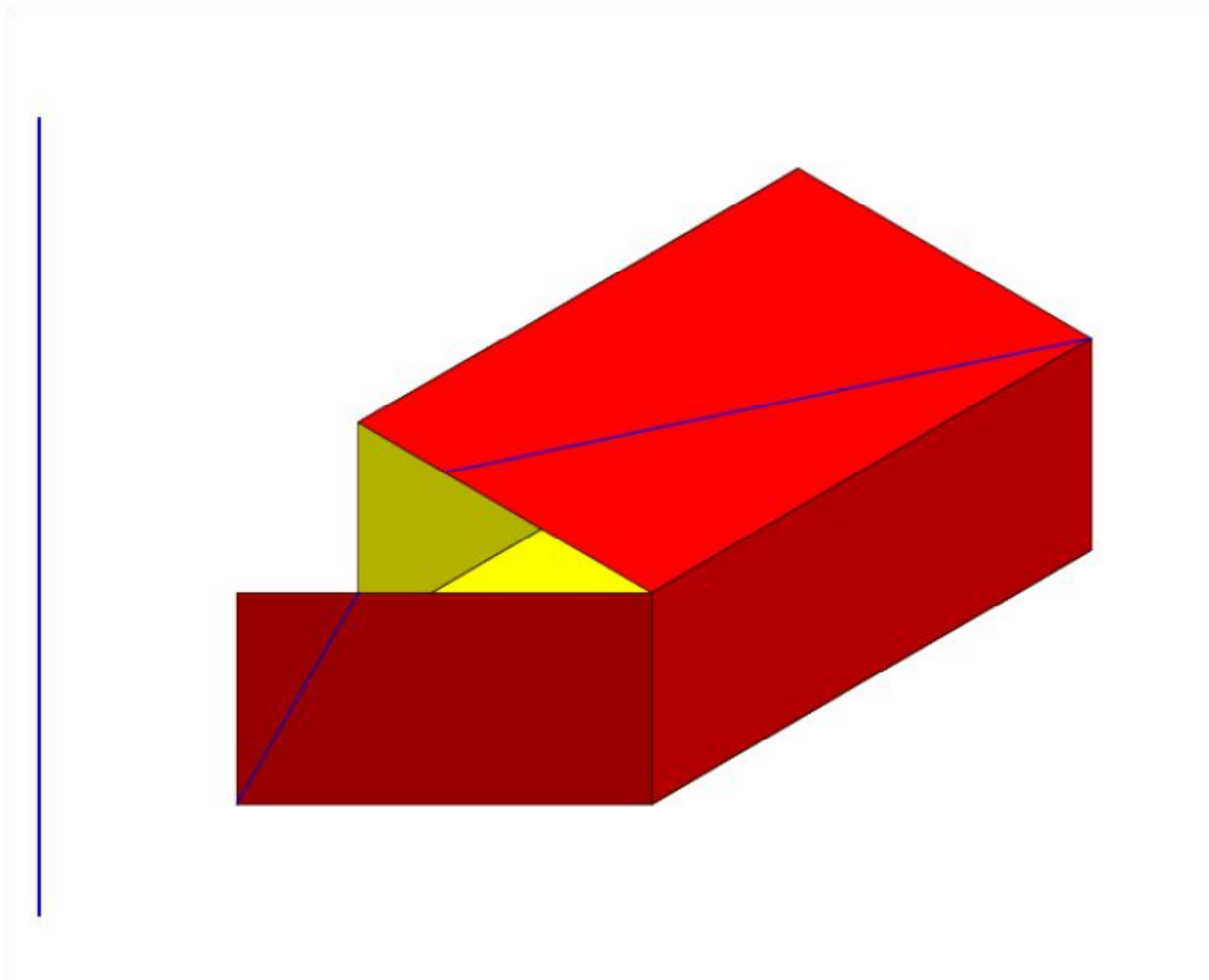



# La fourmi sur la caisse

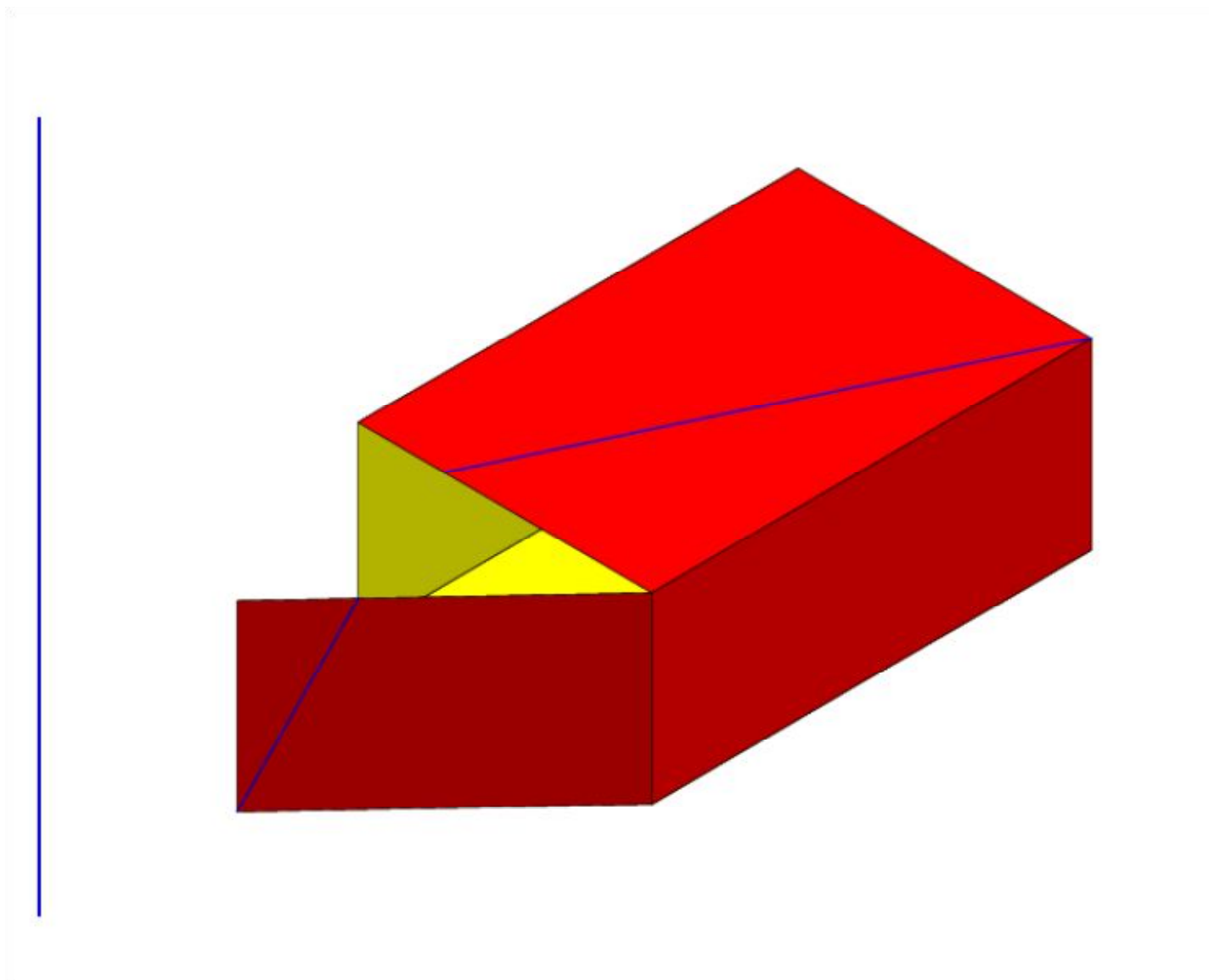

# La fourmi sur la caisse

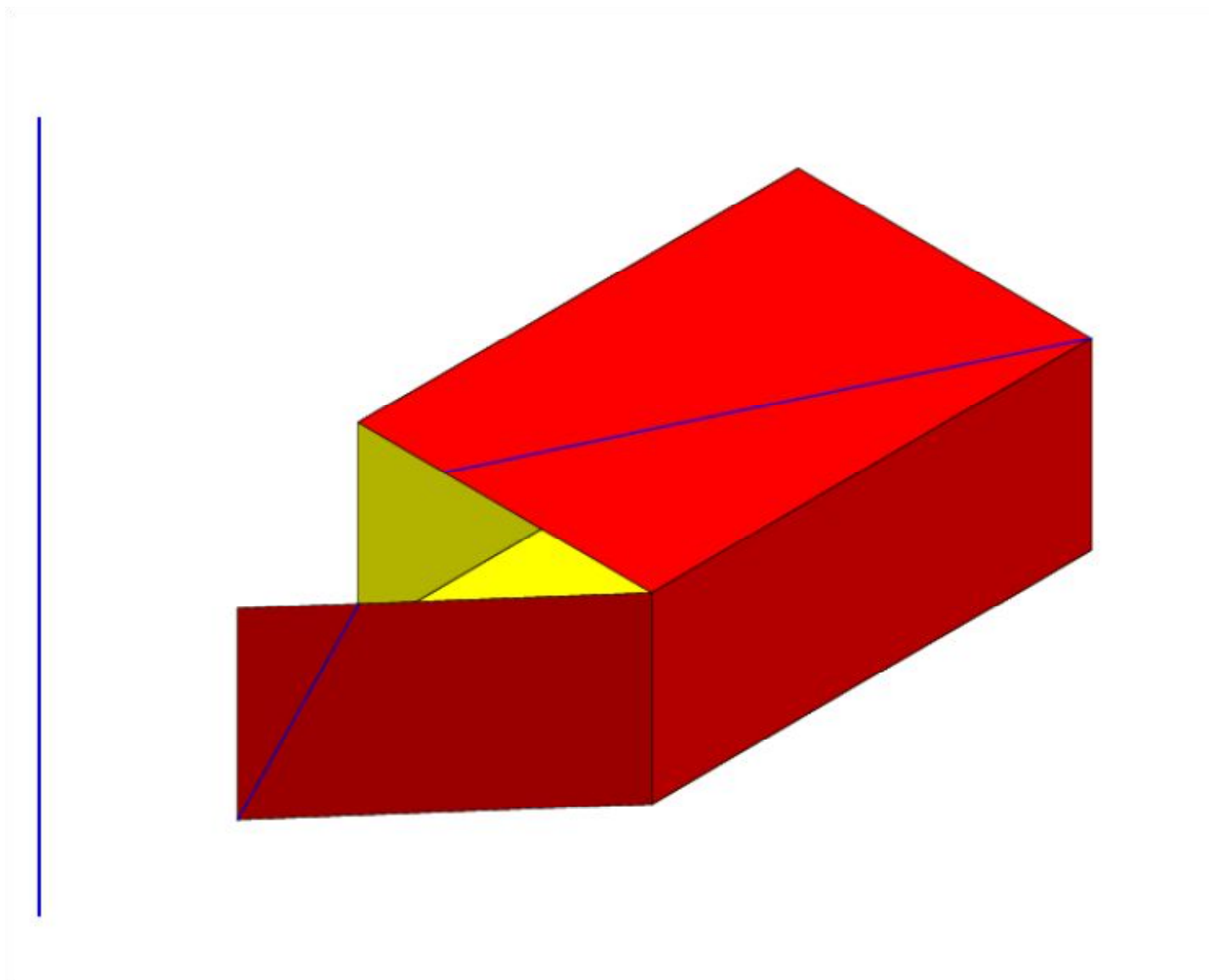

# La fourmi sur la caisse

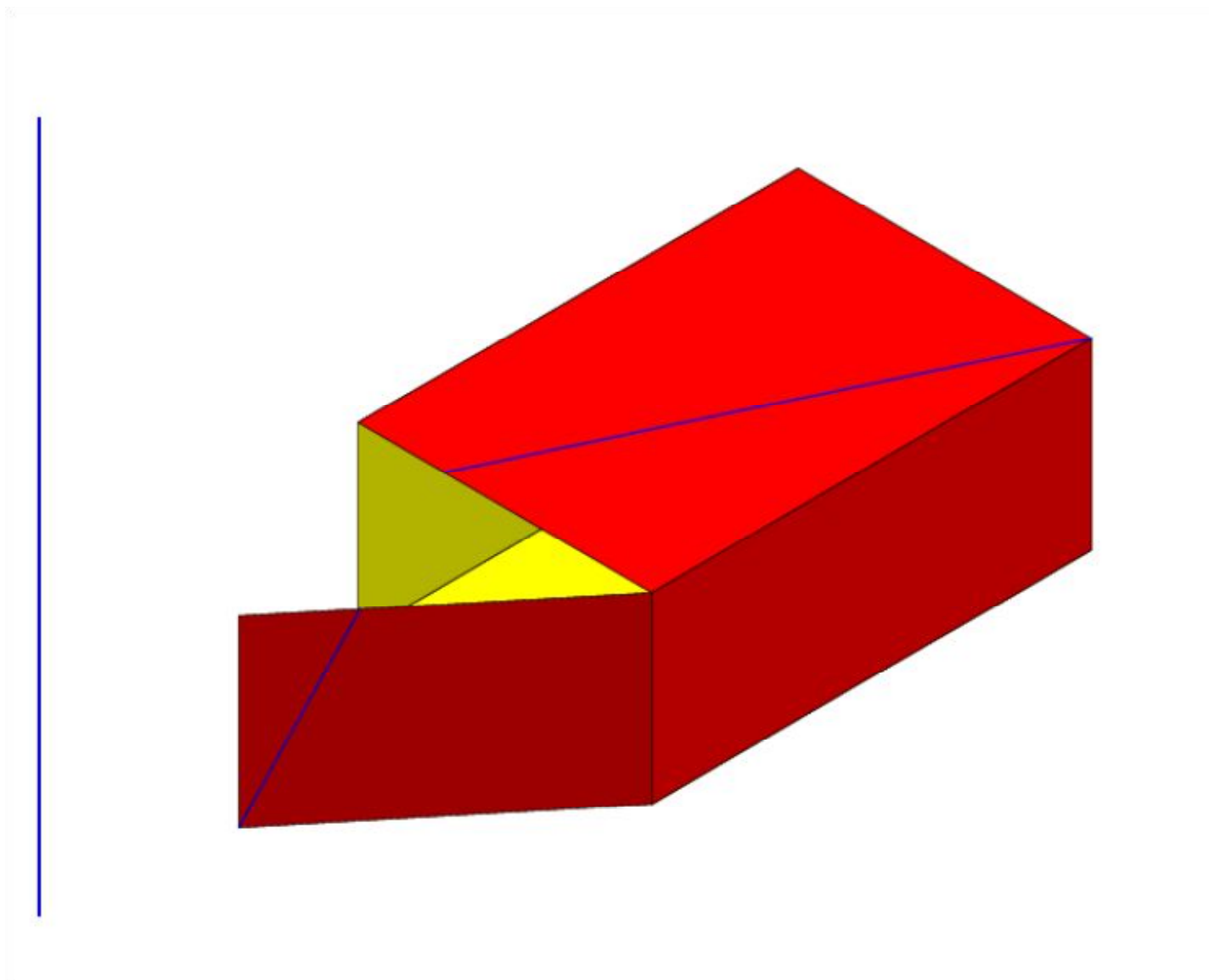

# La fourmi sur la caisse

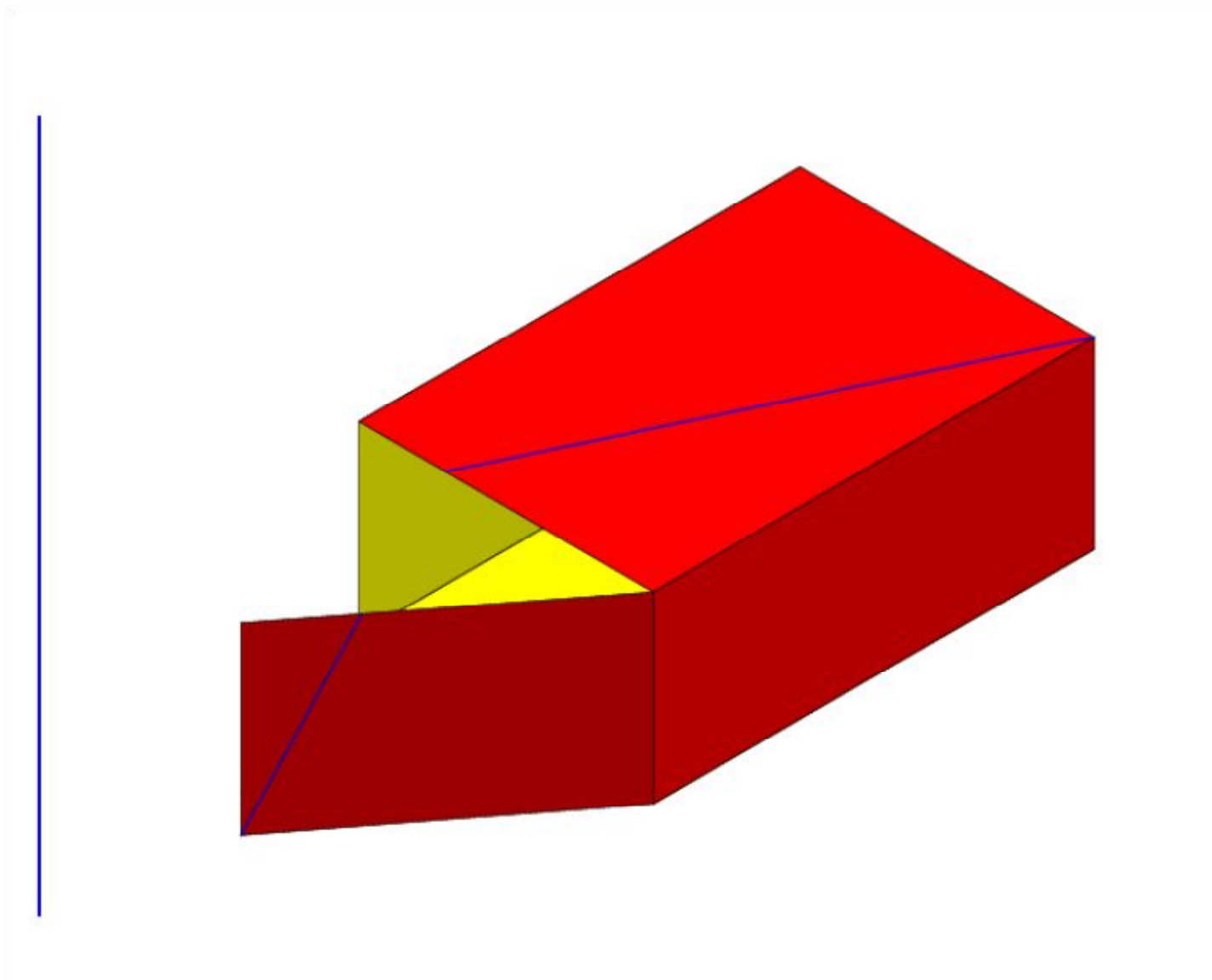

# La fourmi sur la caisse

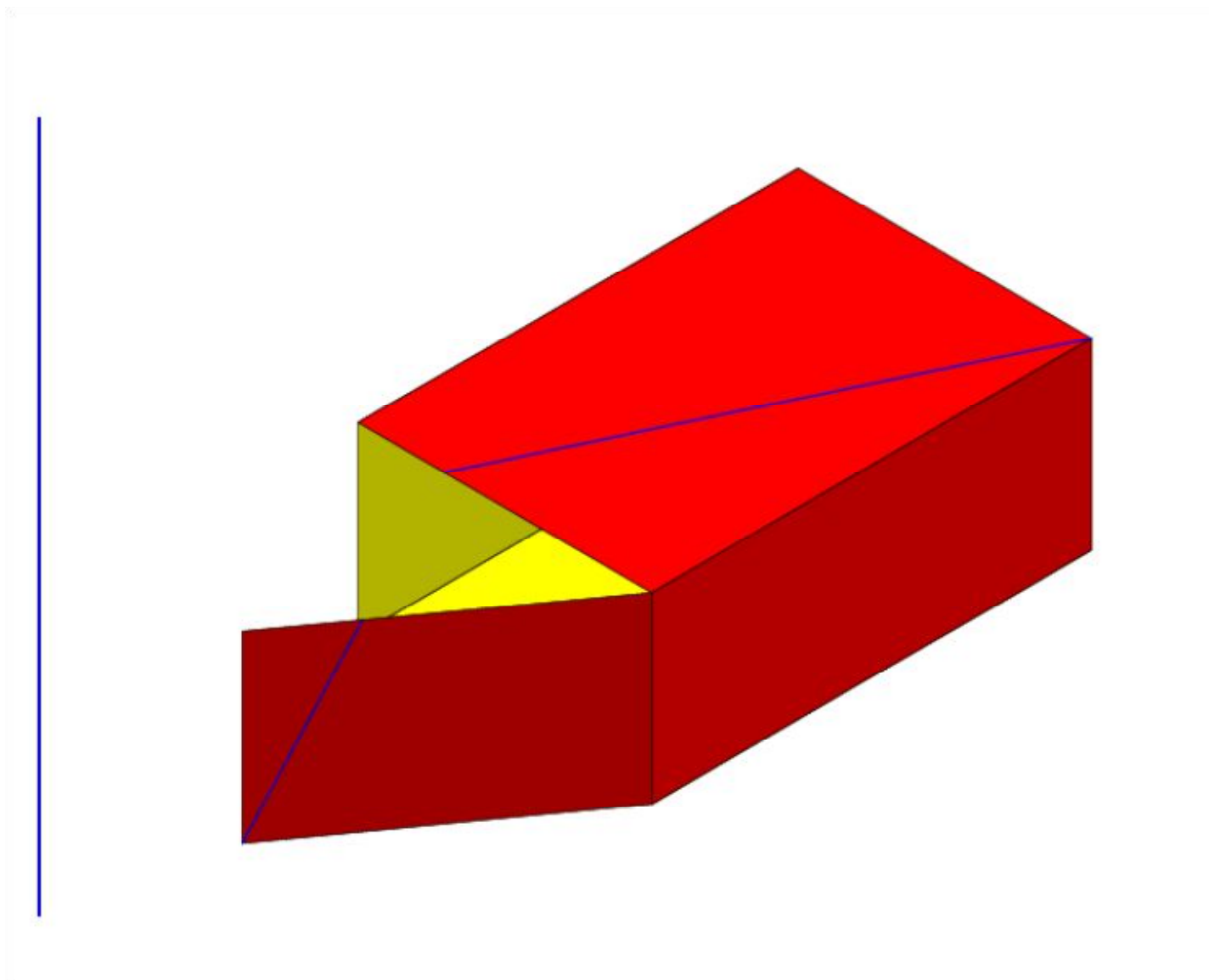

# La fourmi sur la caisse

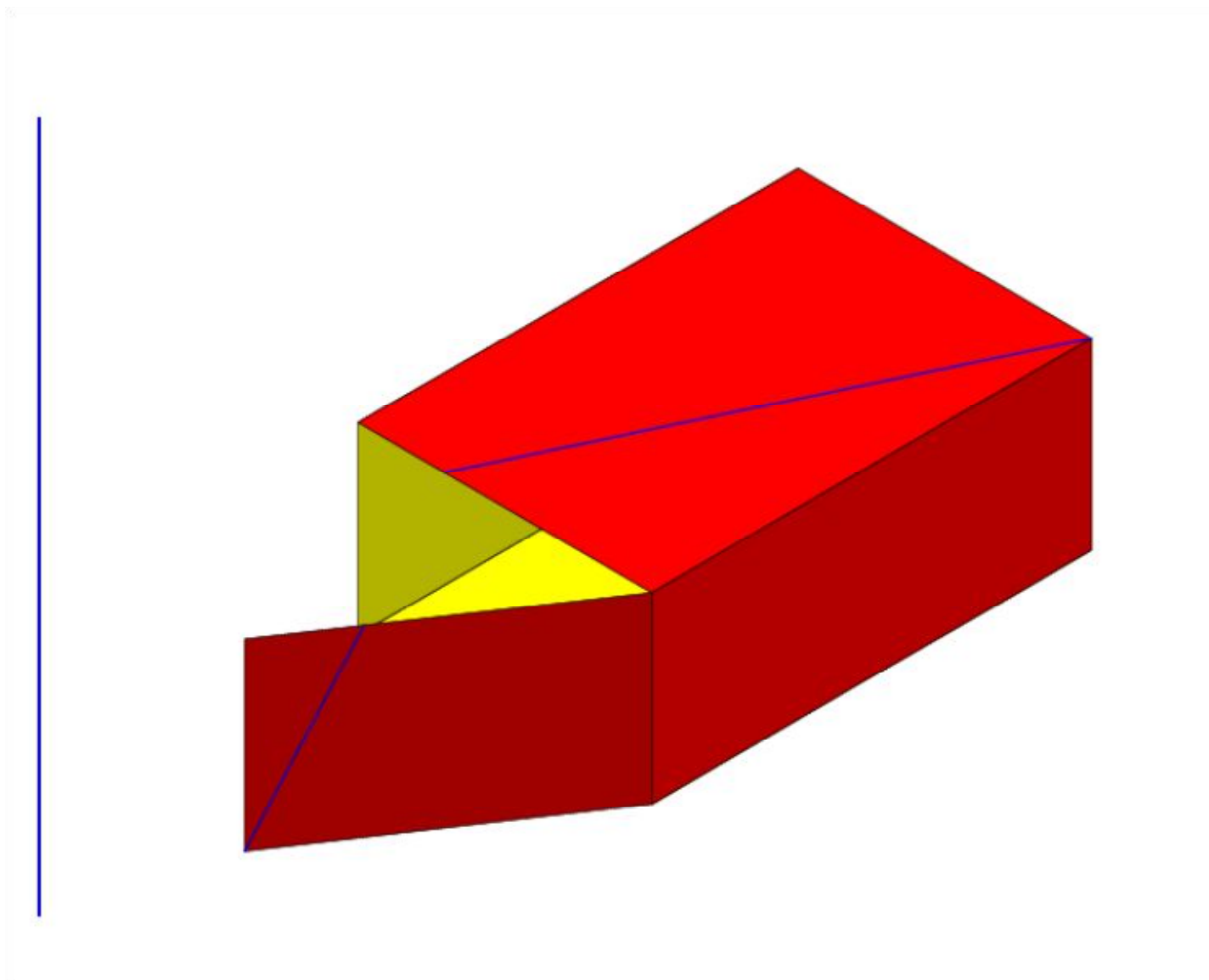

# La fourmi sur la caisse

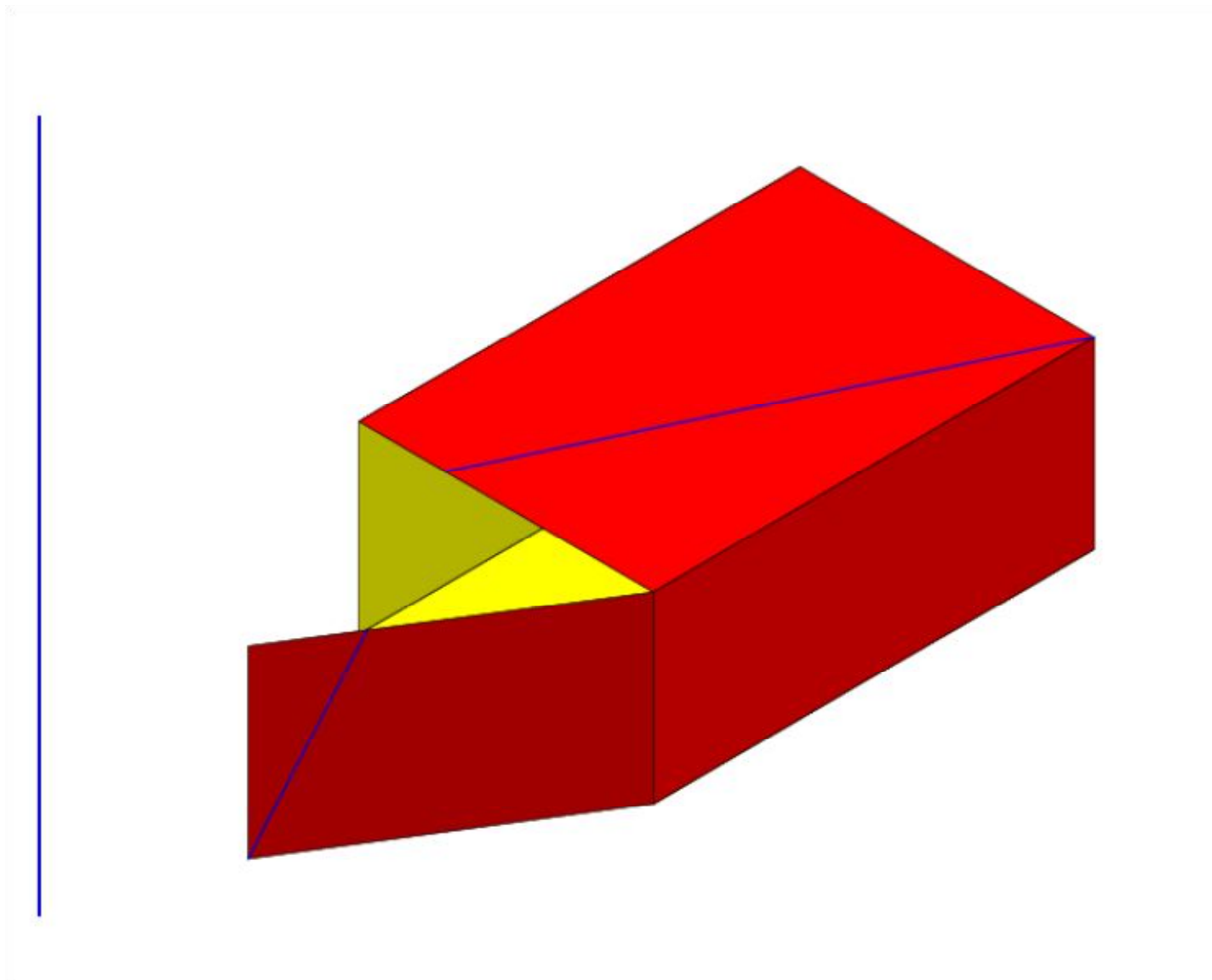

# La fourmi sur la caisse

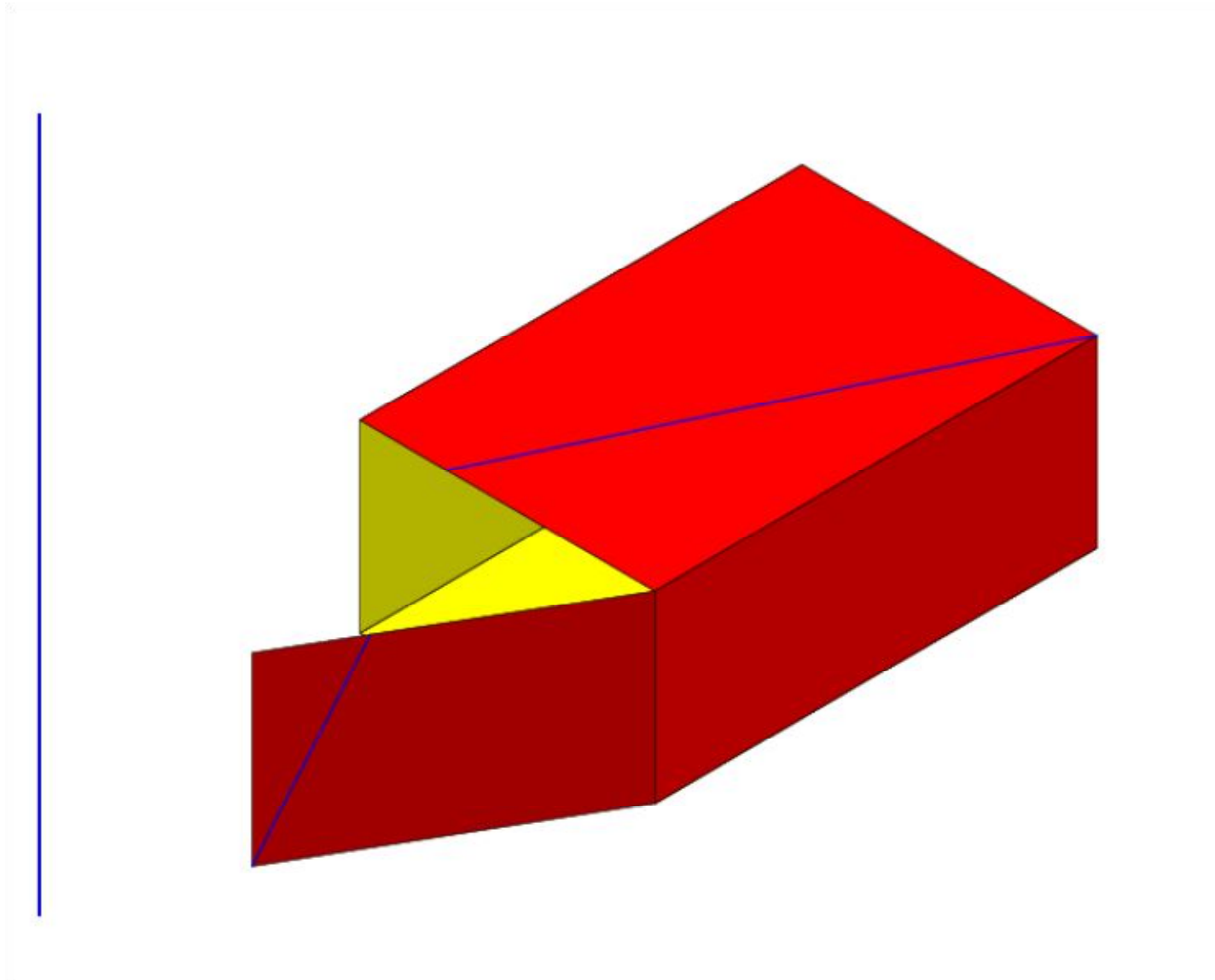



# La fourmi sur la caisse

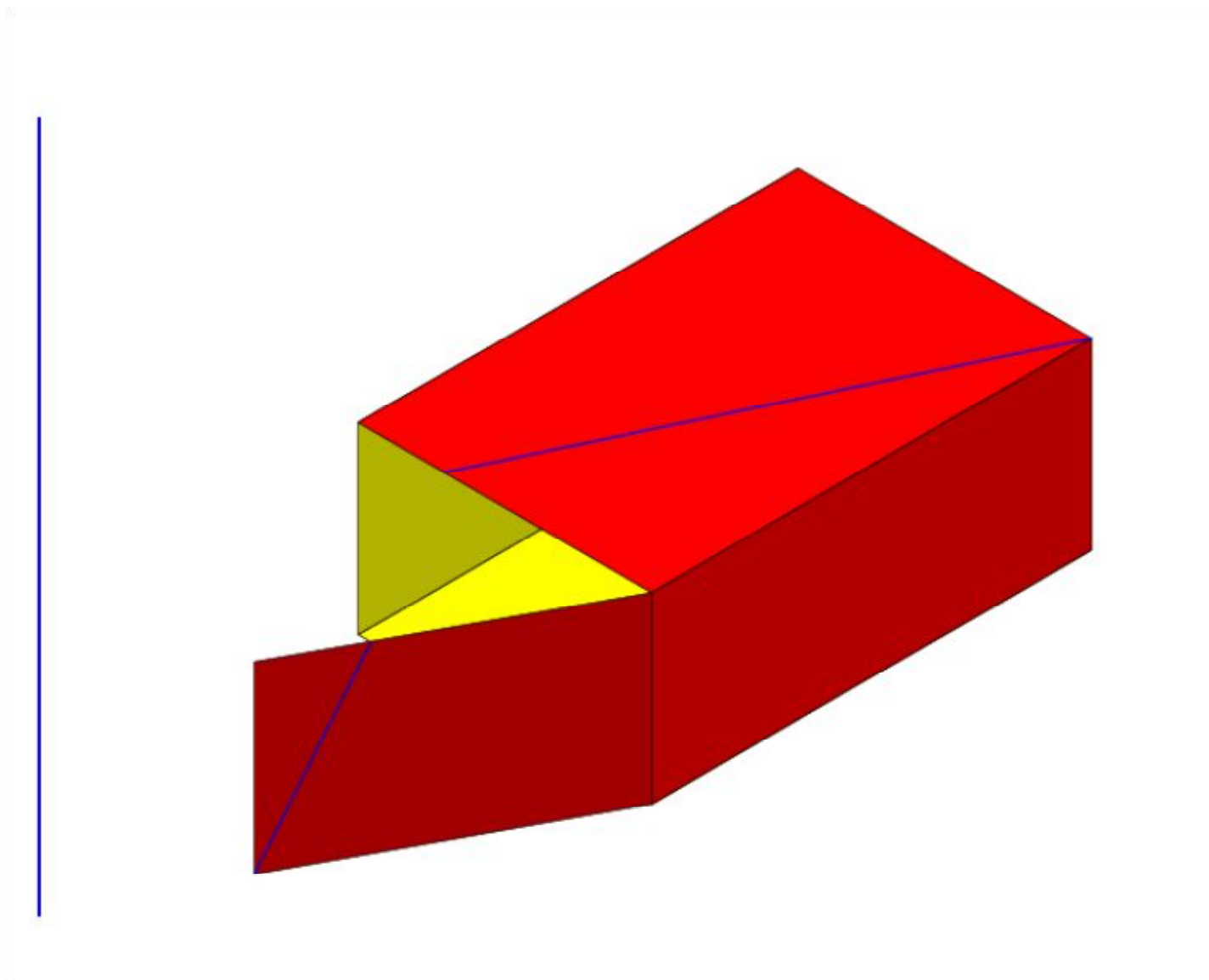

# La fourmi sur la caisse

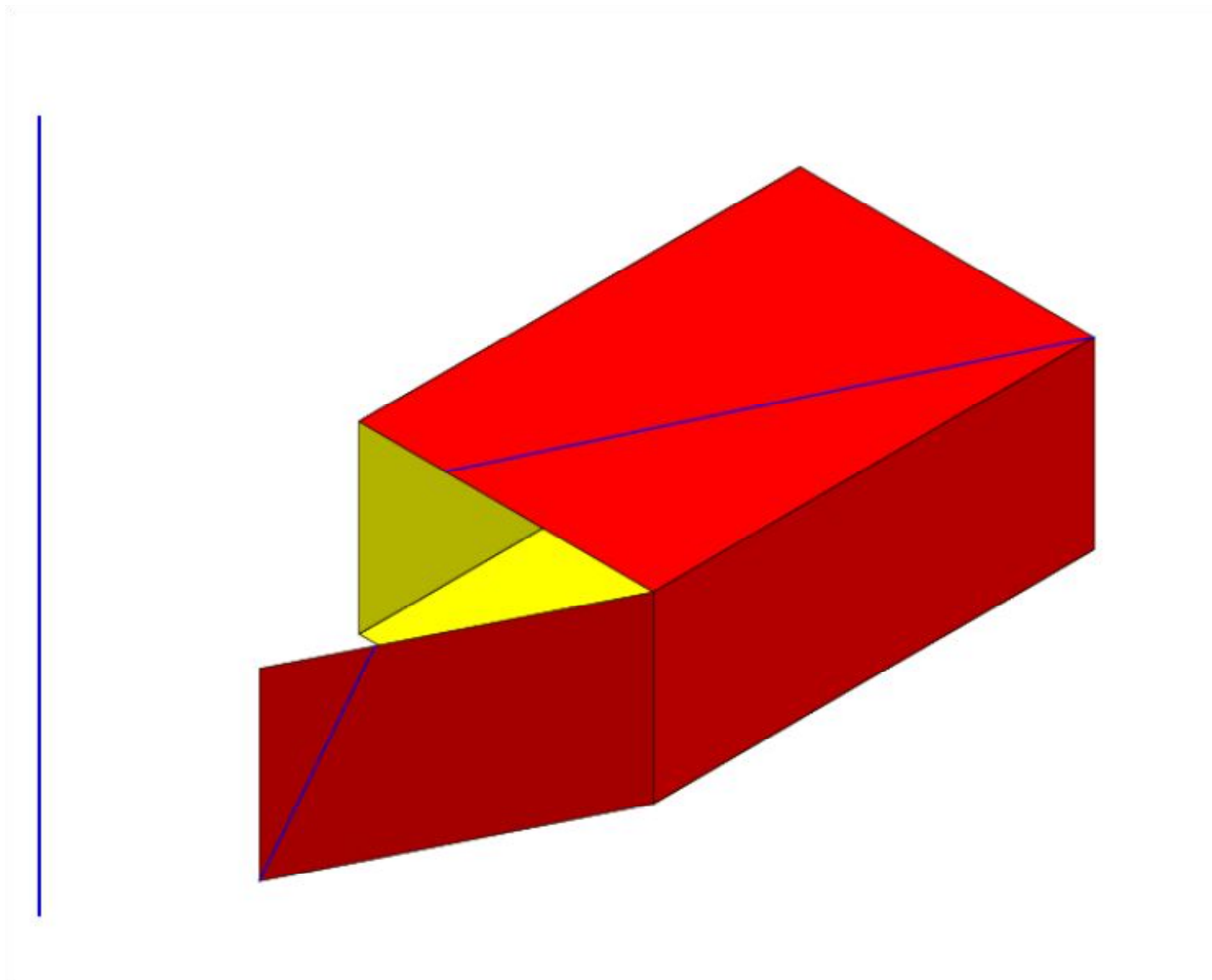

# La fourmi sur la caisse

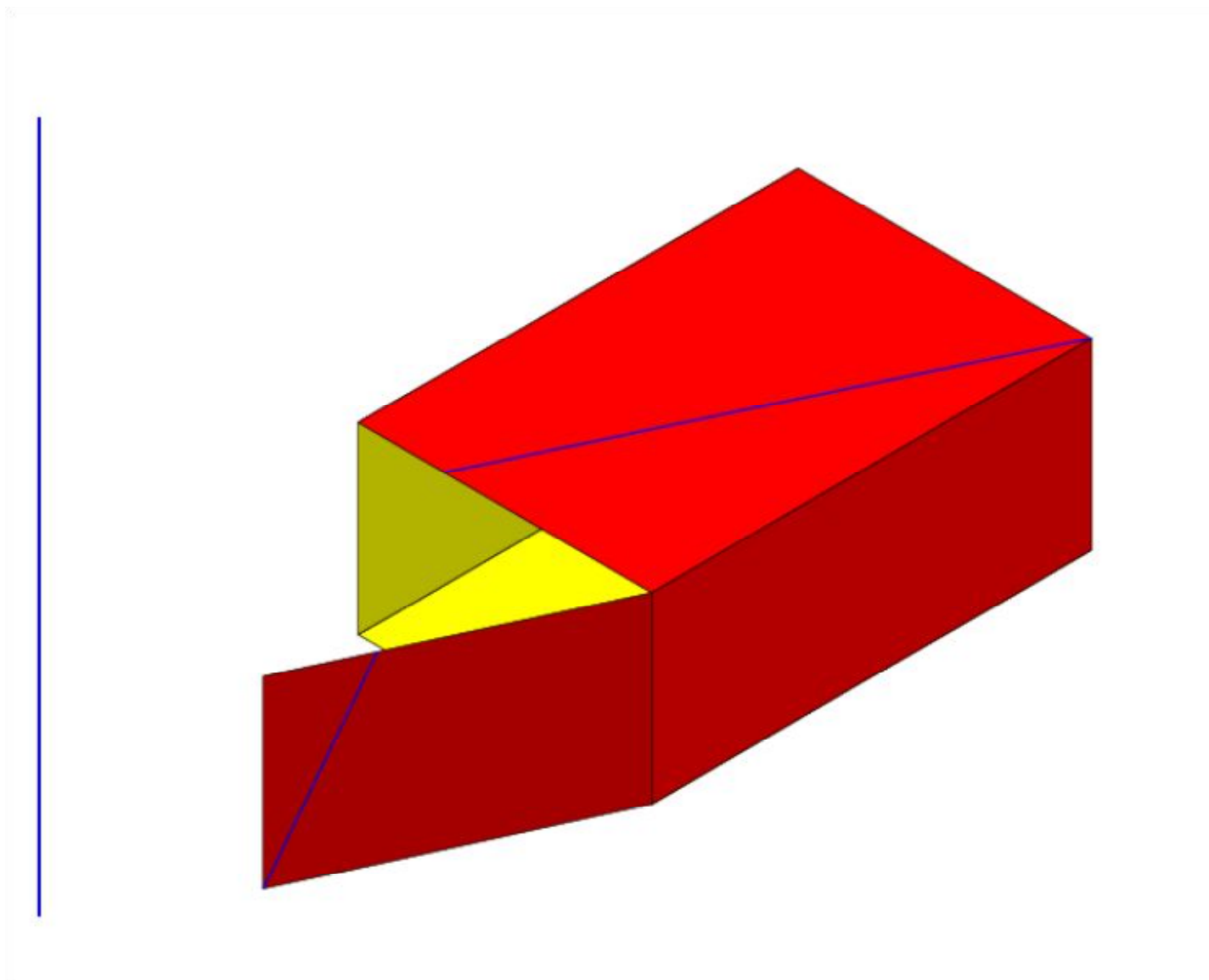

# La fourmi sur la caisse

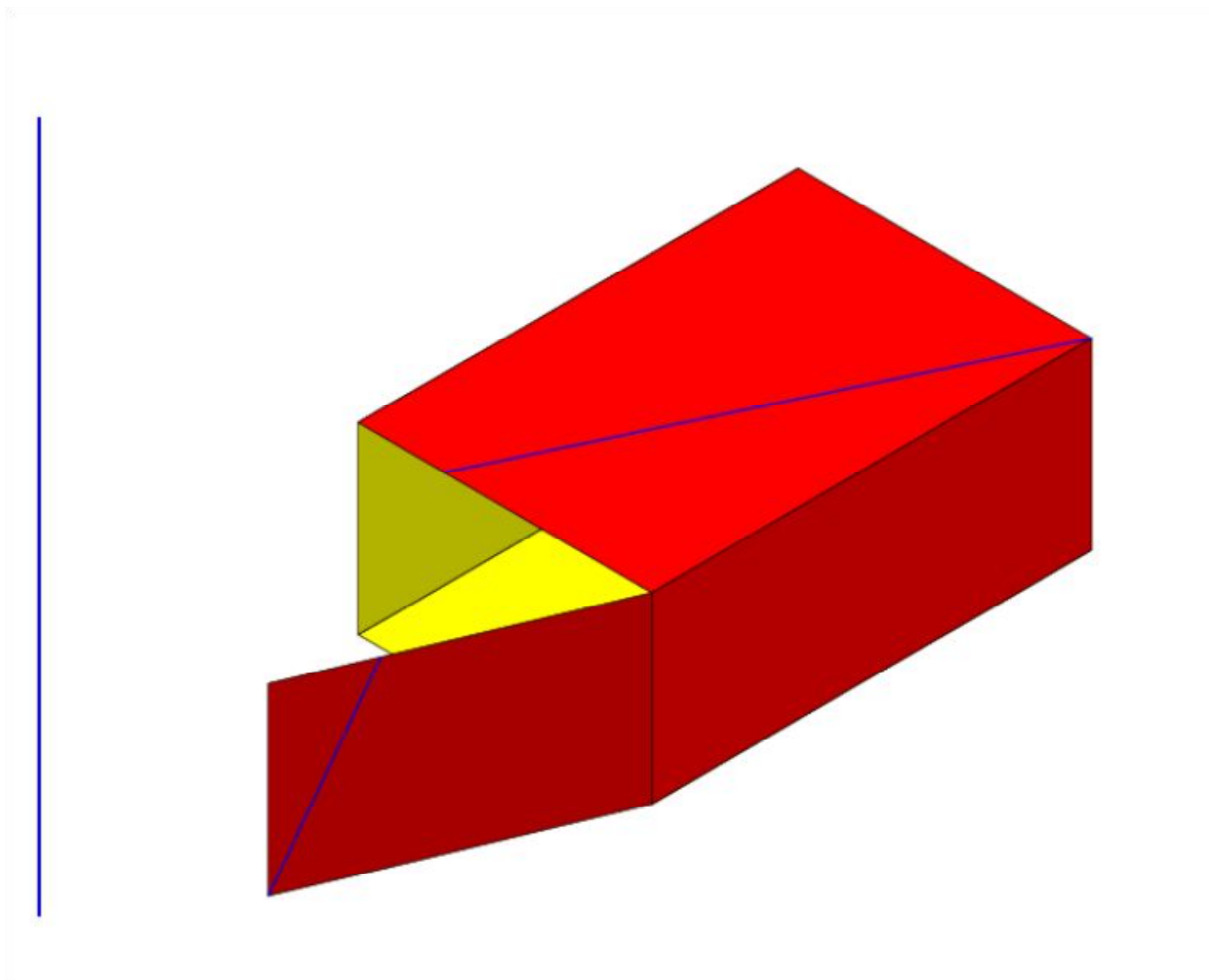

# La fourmi sur la caisse

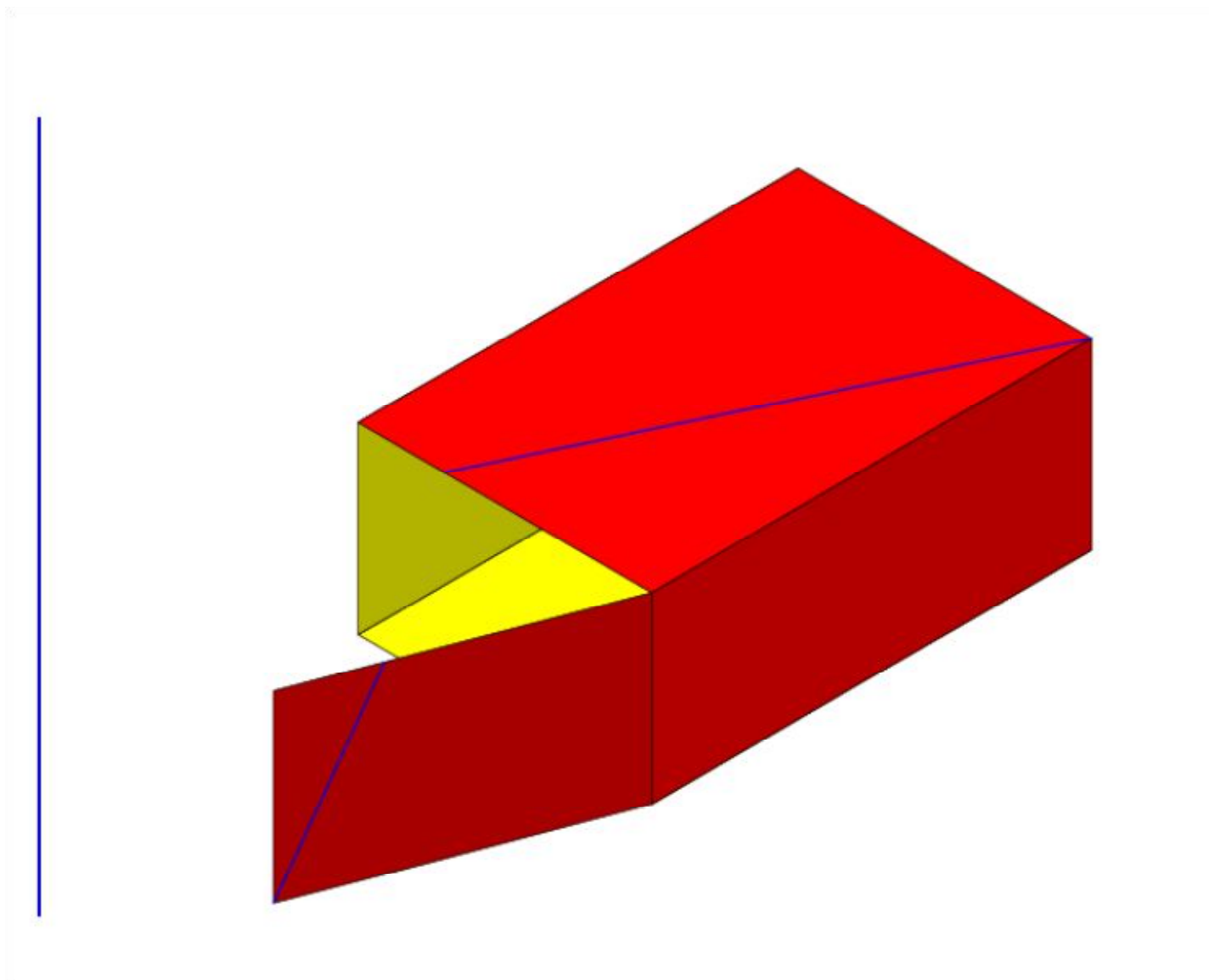

# La fourmi sur la caisse

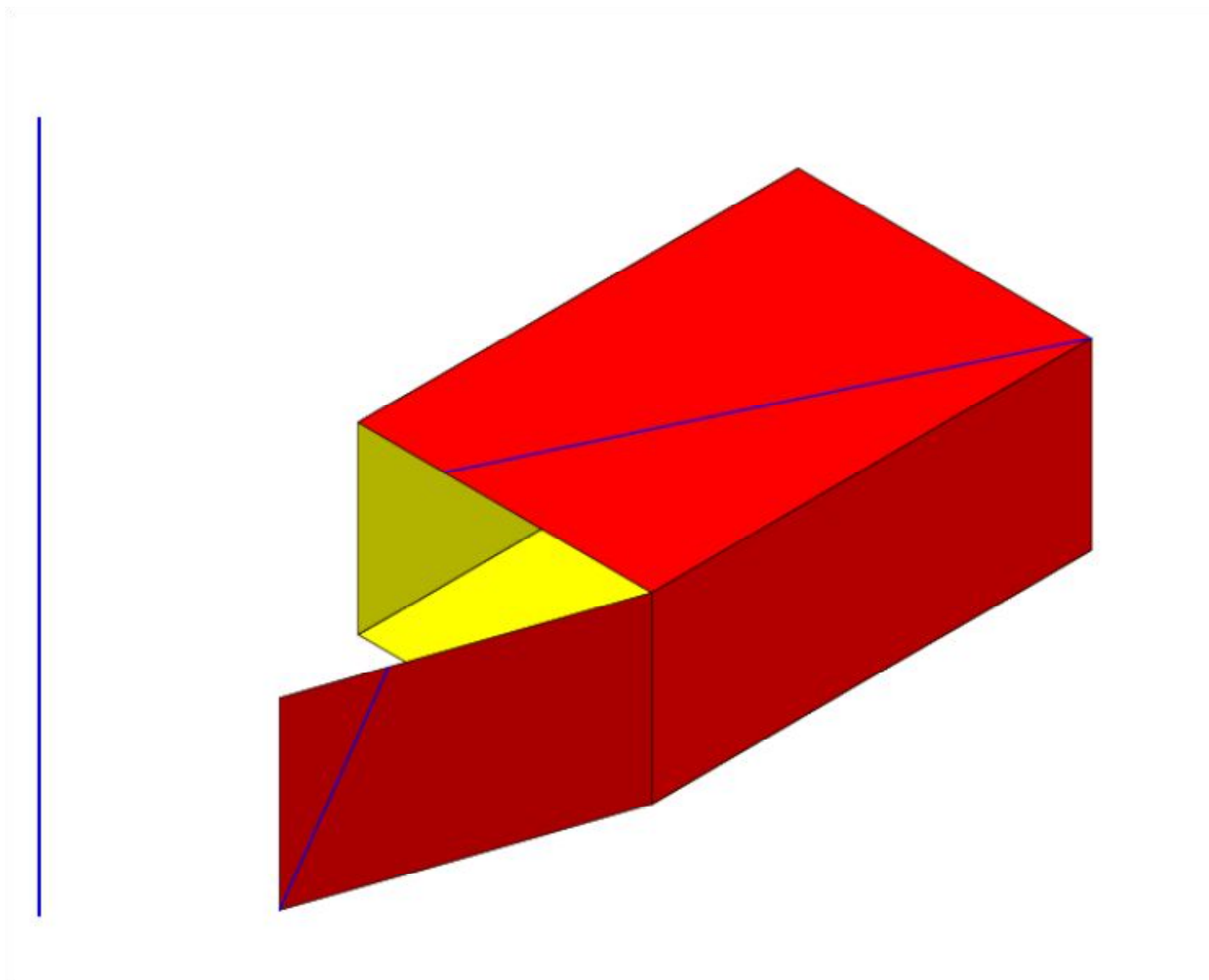

# La fourmi sur la caisse

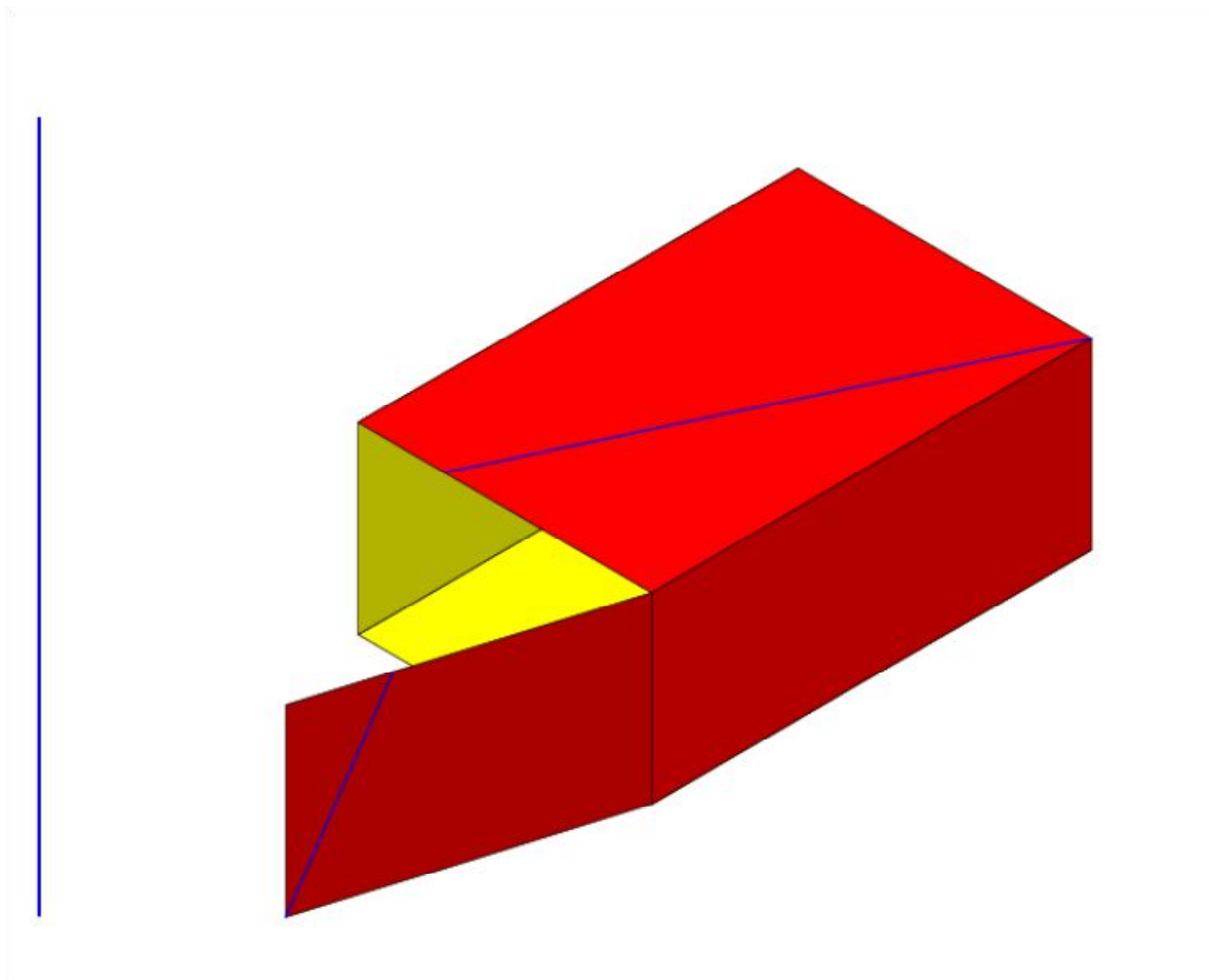

# La fourmi sur la caisse

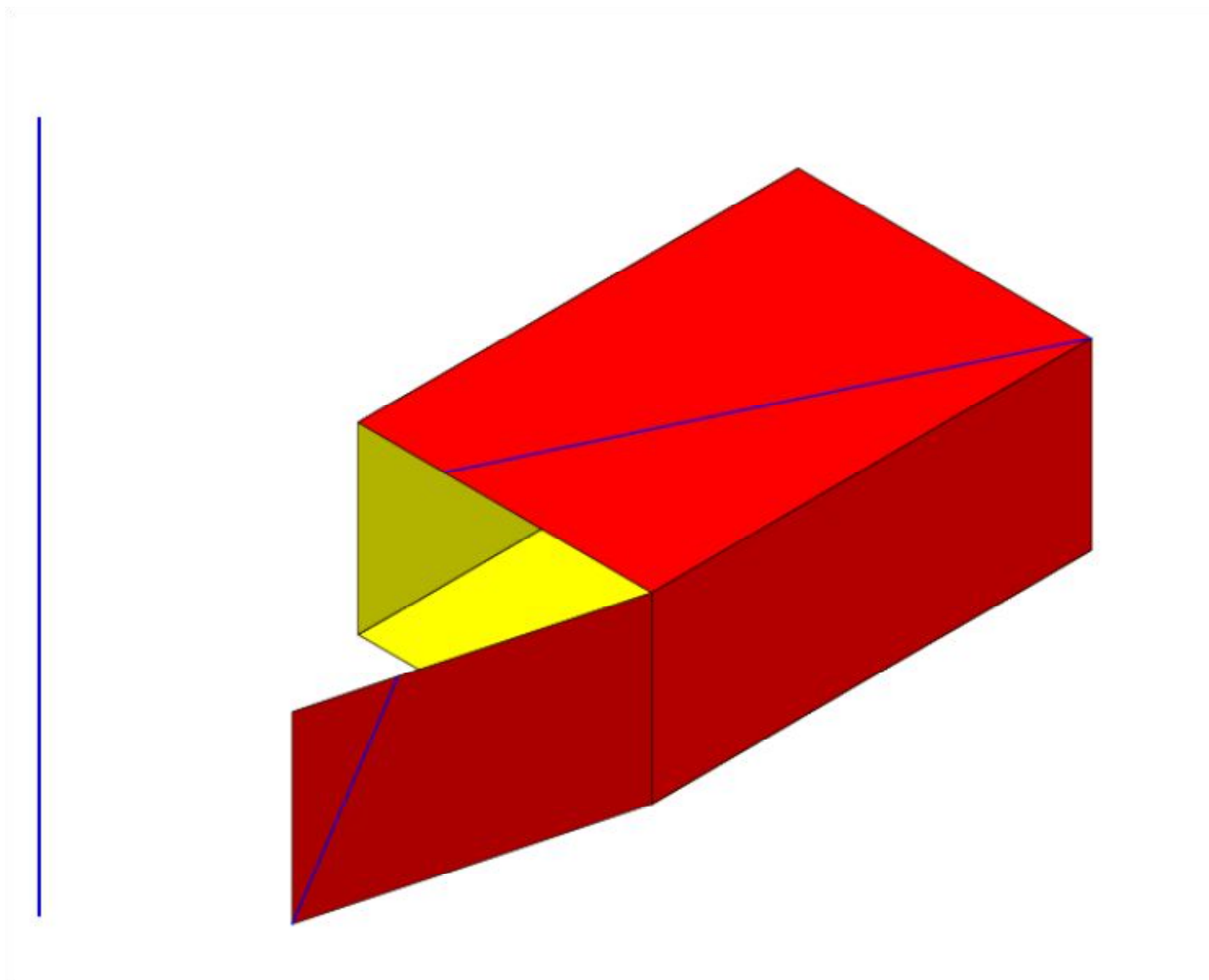



# La fourmi sur la caisse

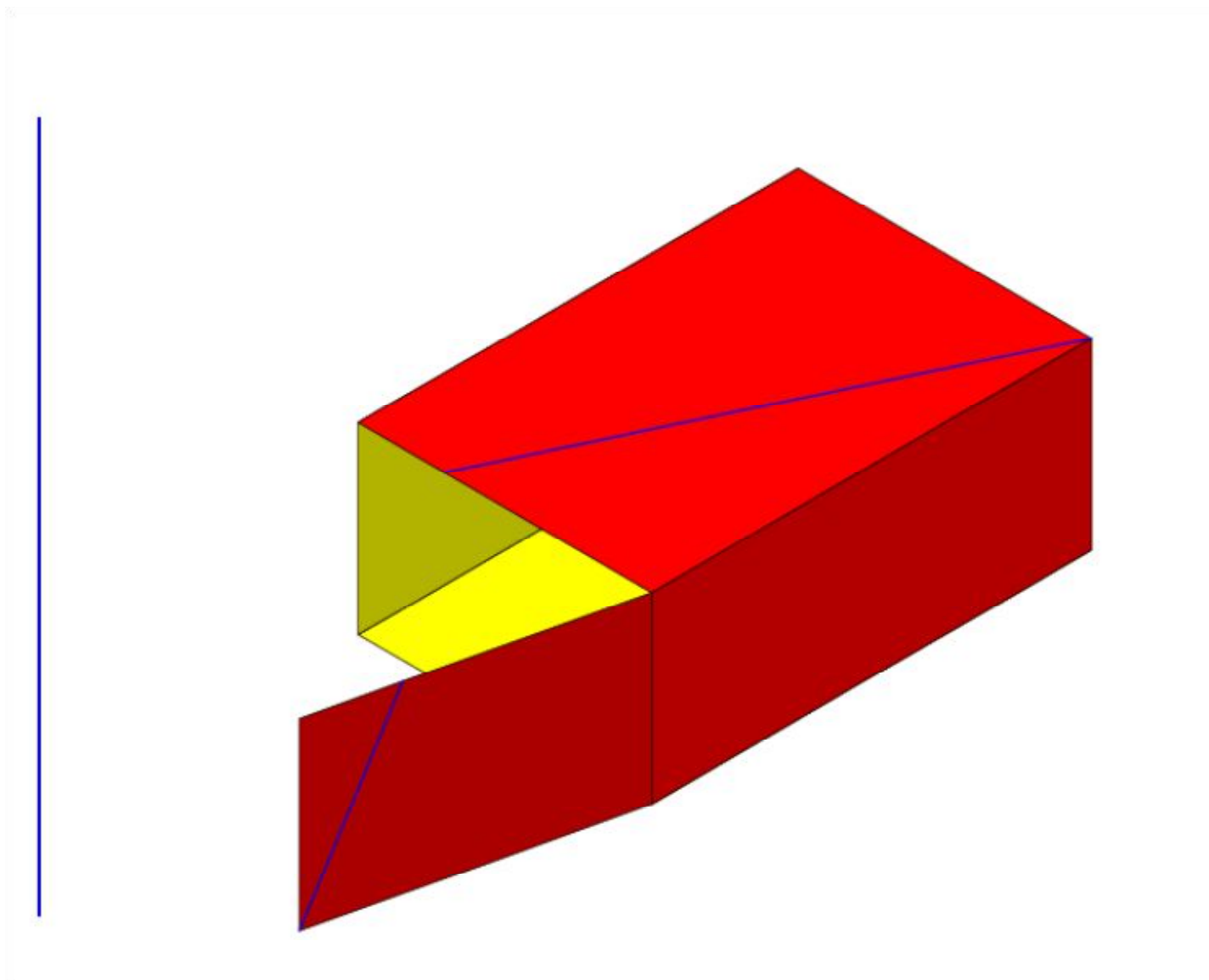

# La fourmi sur la caisse

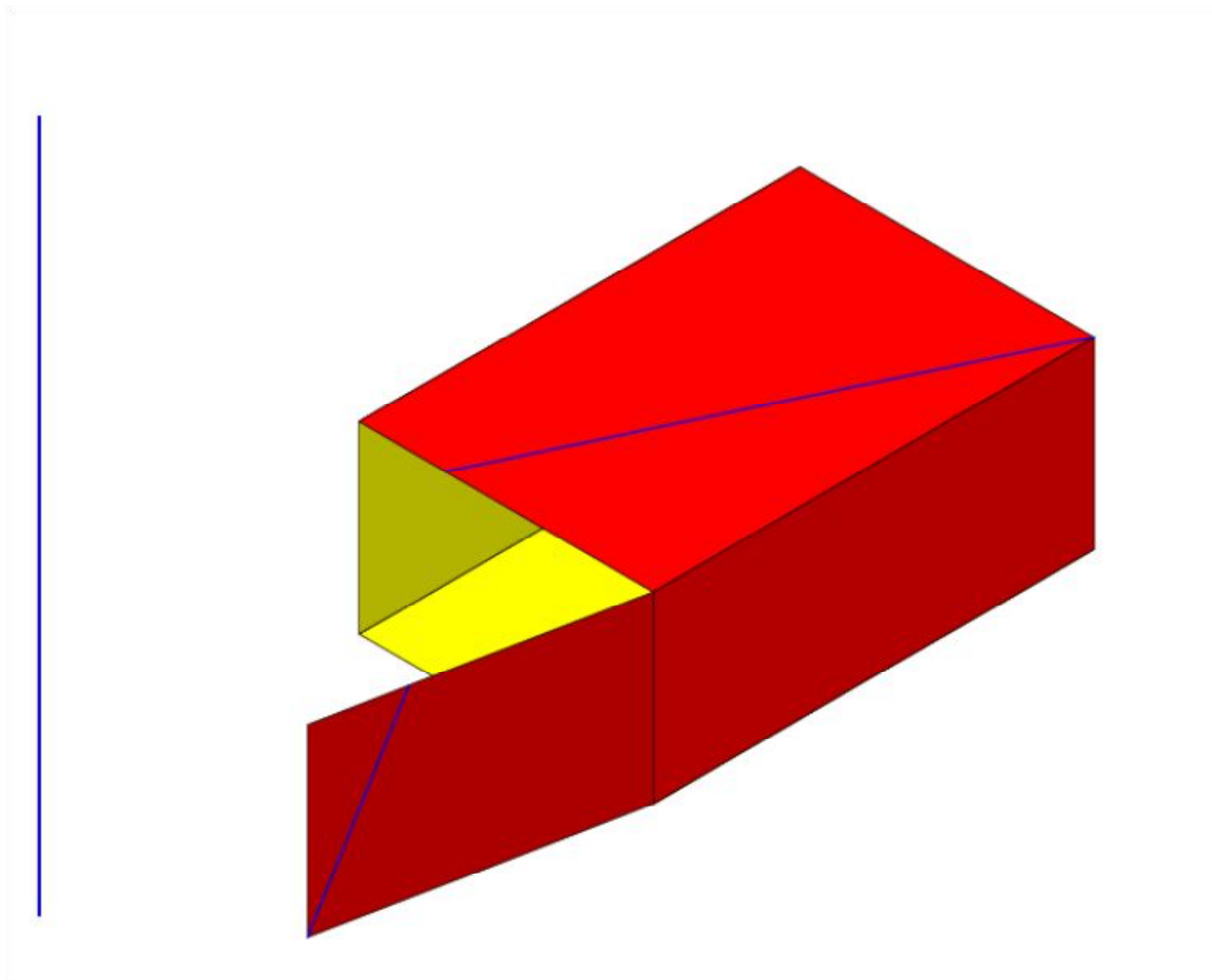

# La fourmi sur la caisse

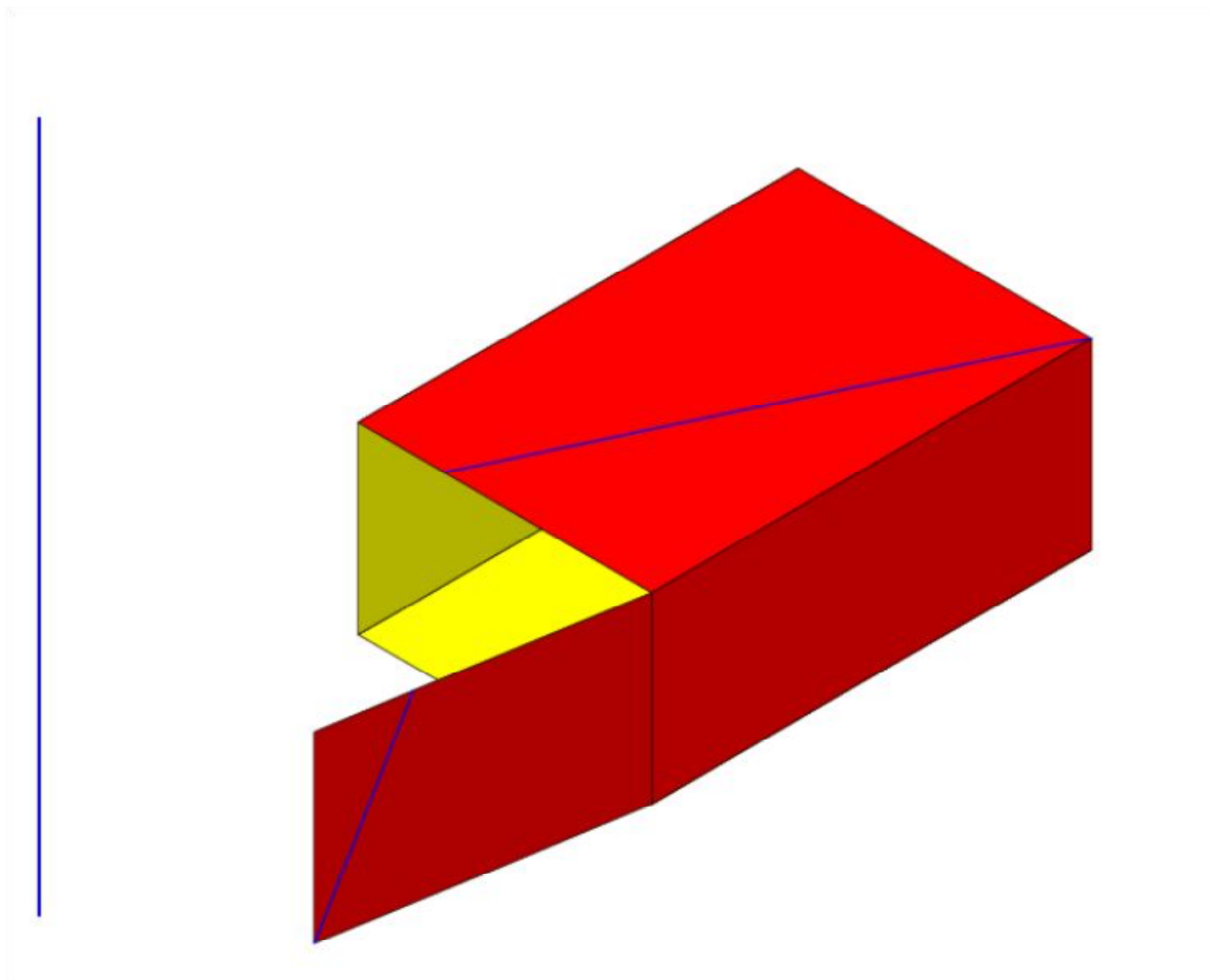

# La fourmi sur la caisse

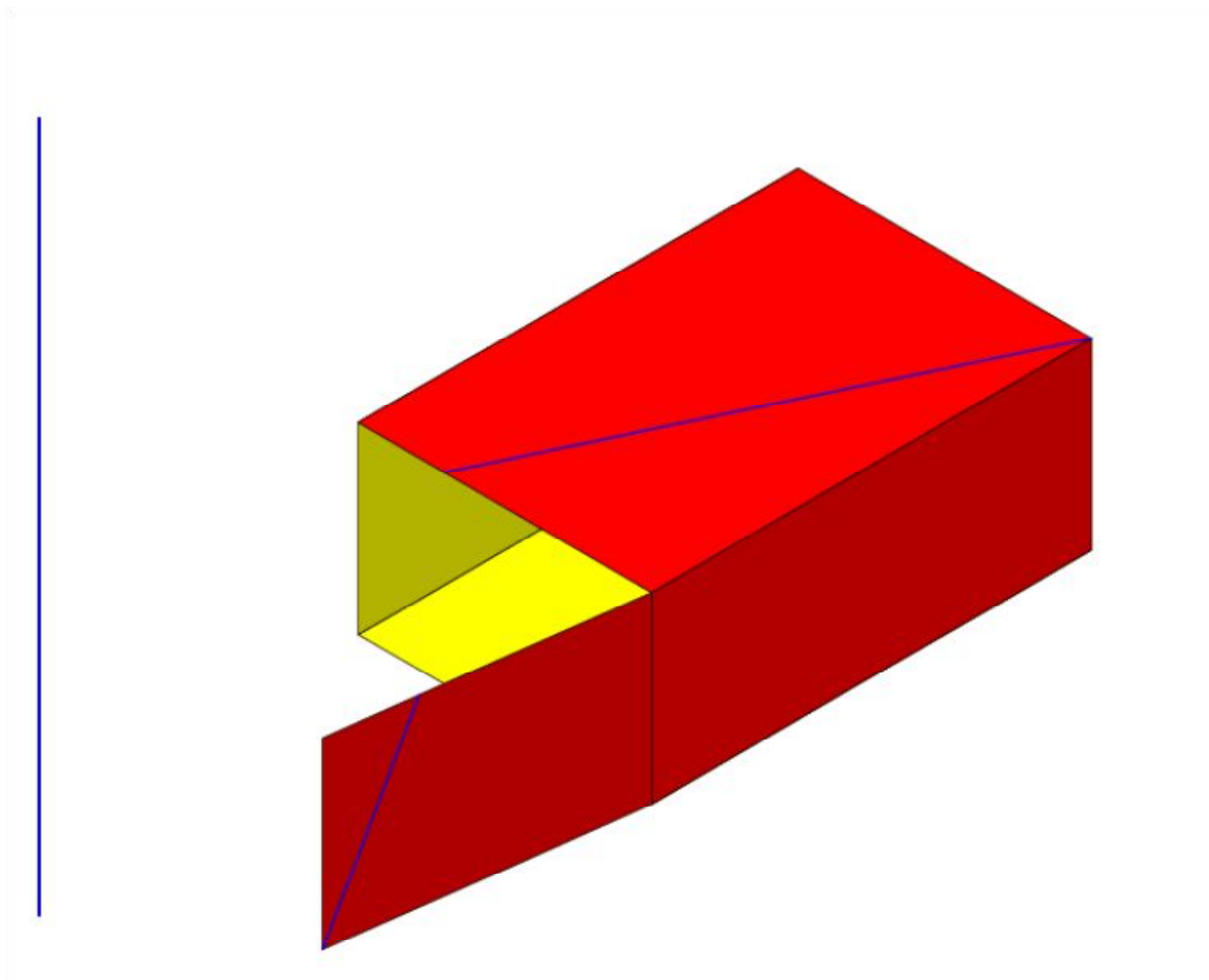

# La fourmi sur la caisse

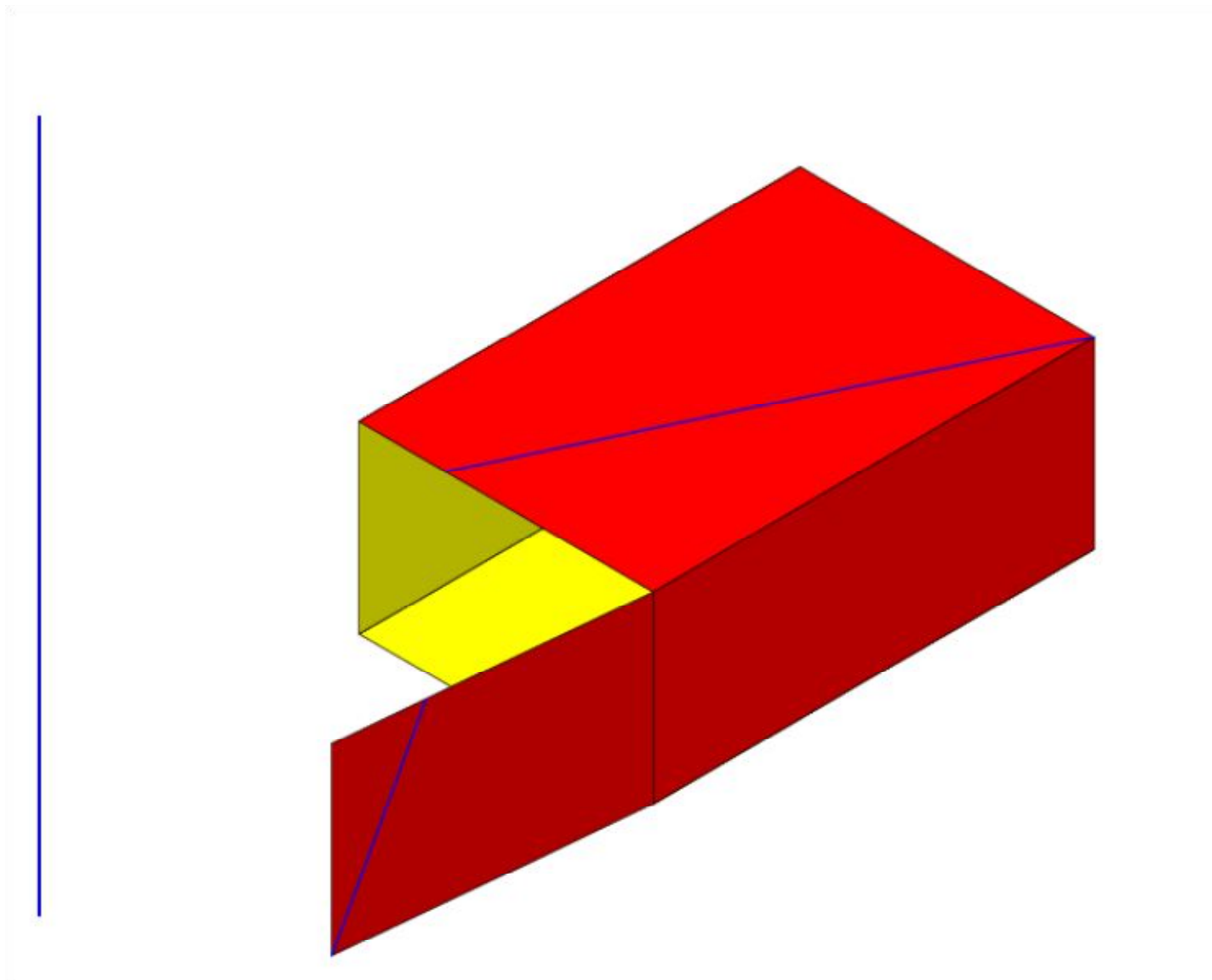

# La fourmi sur la caisse

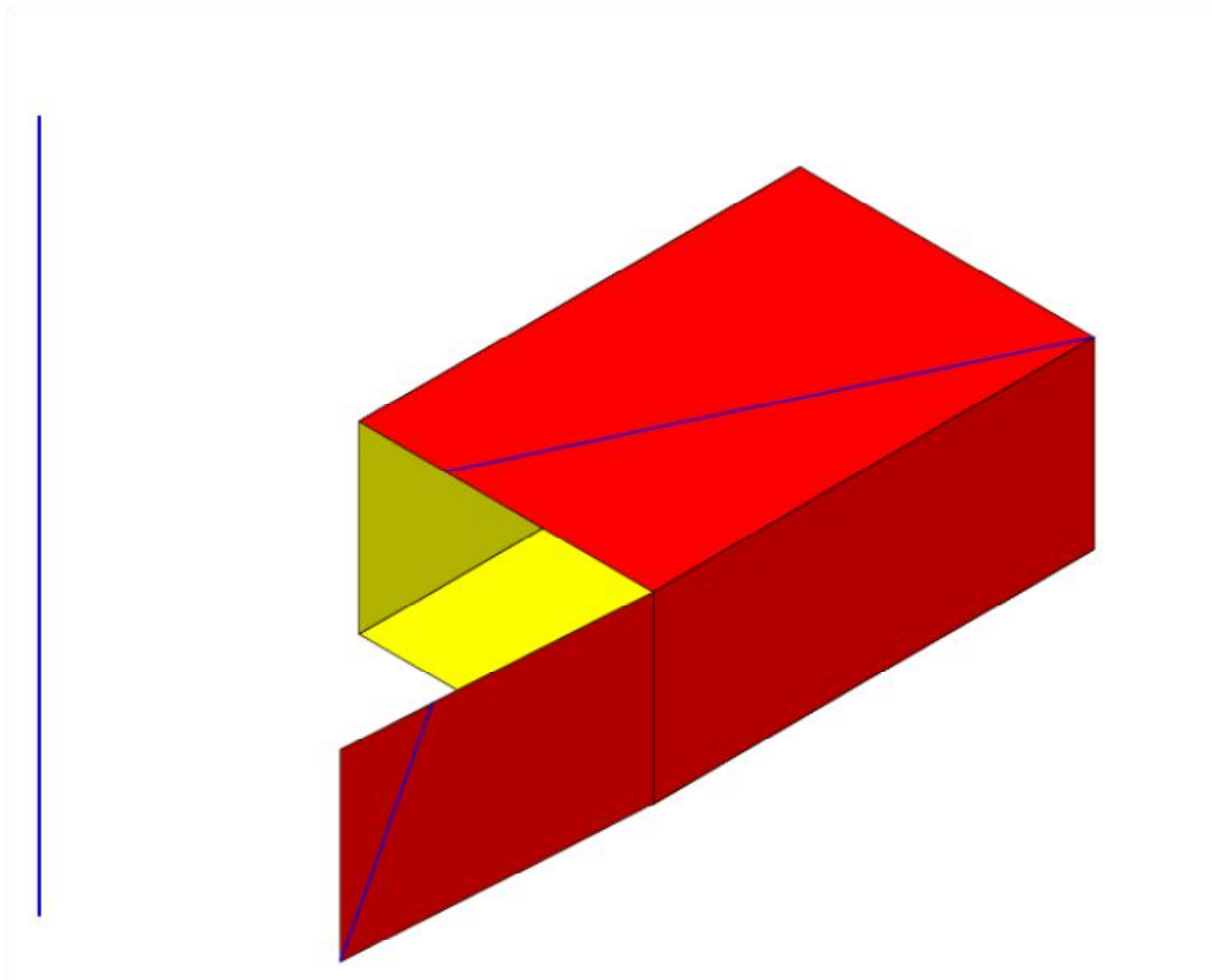

# La fourmi sur la caisse

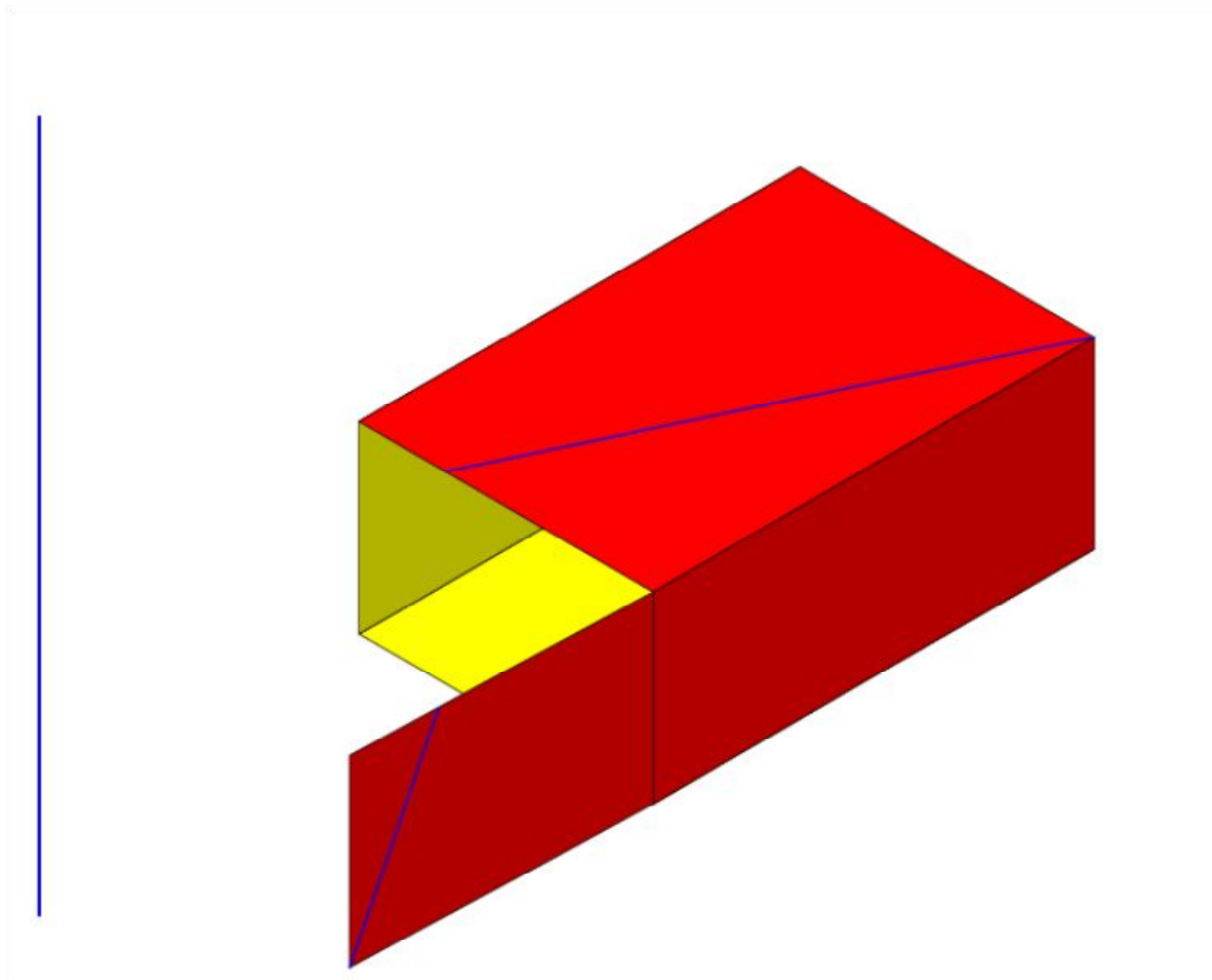

# La fourmi sur la caisse

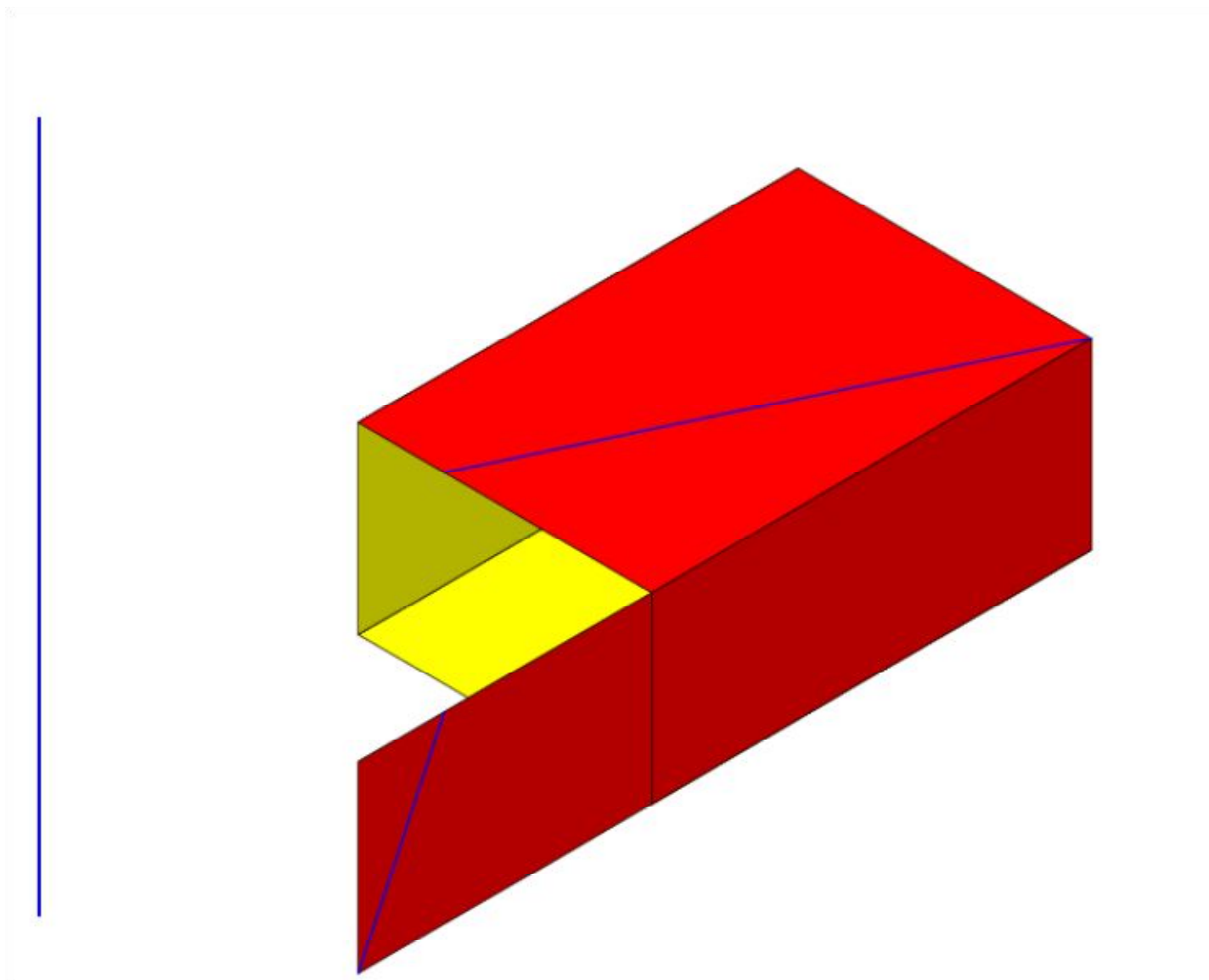



# La fourmi sur la caisse

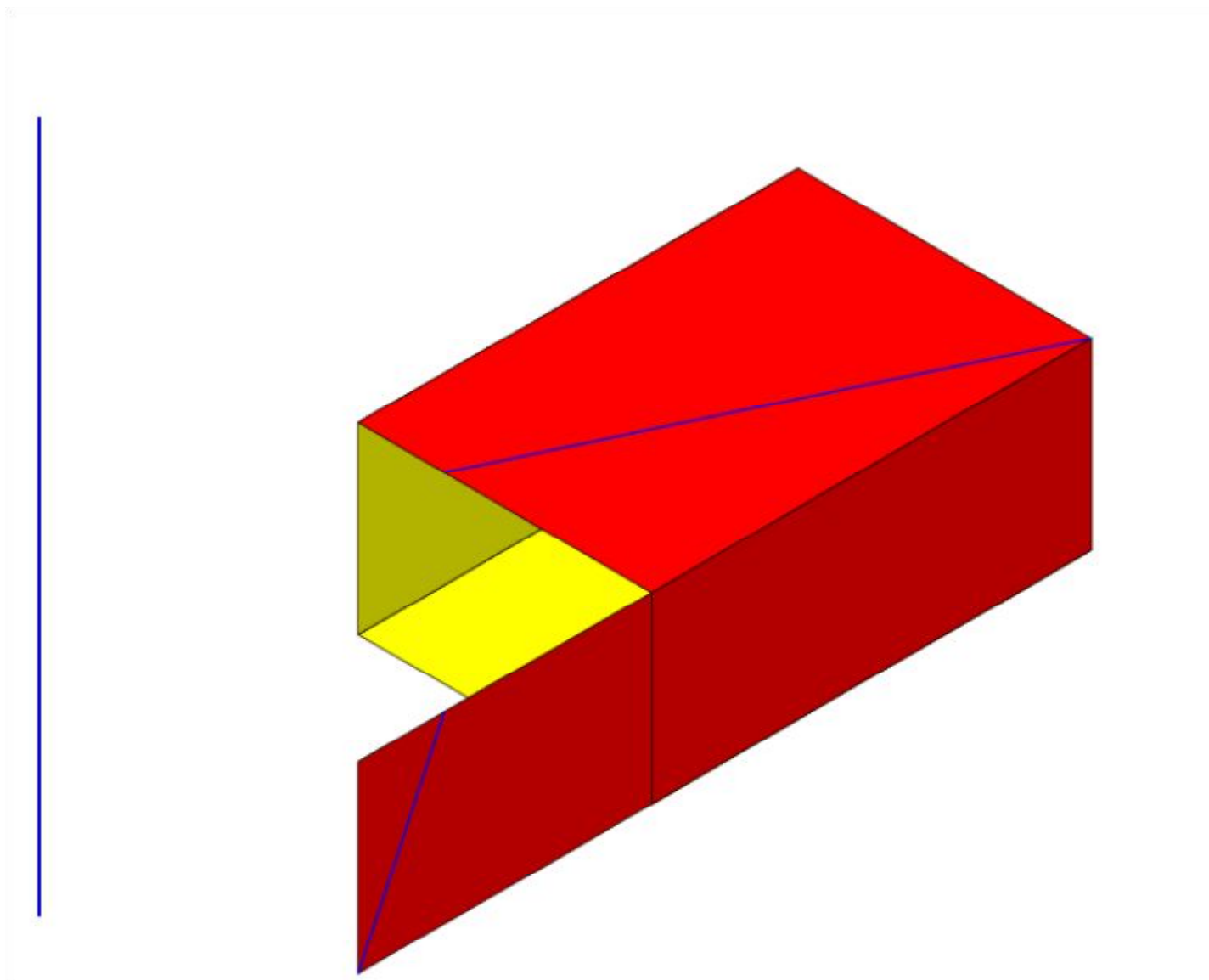

# La fourmi sur la caisse

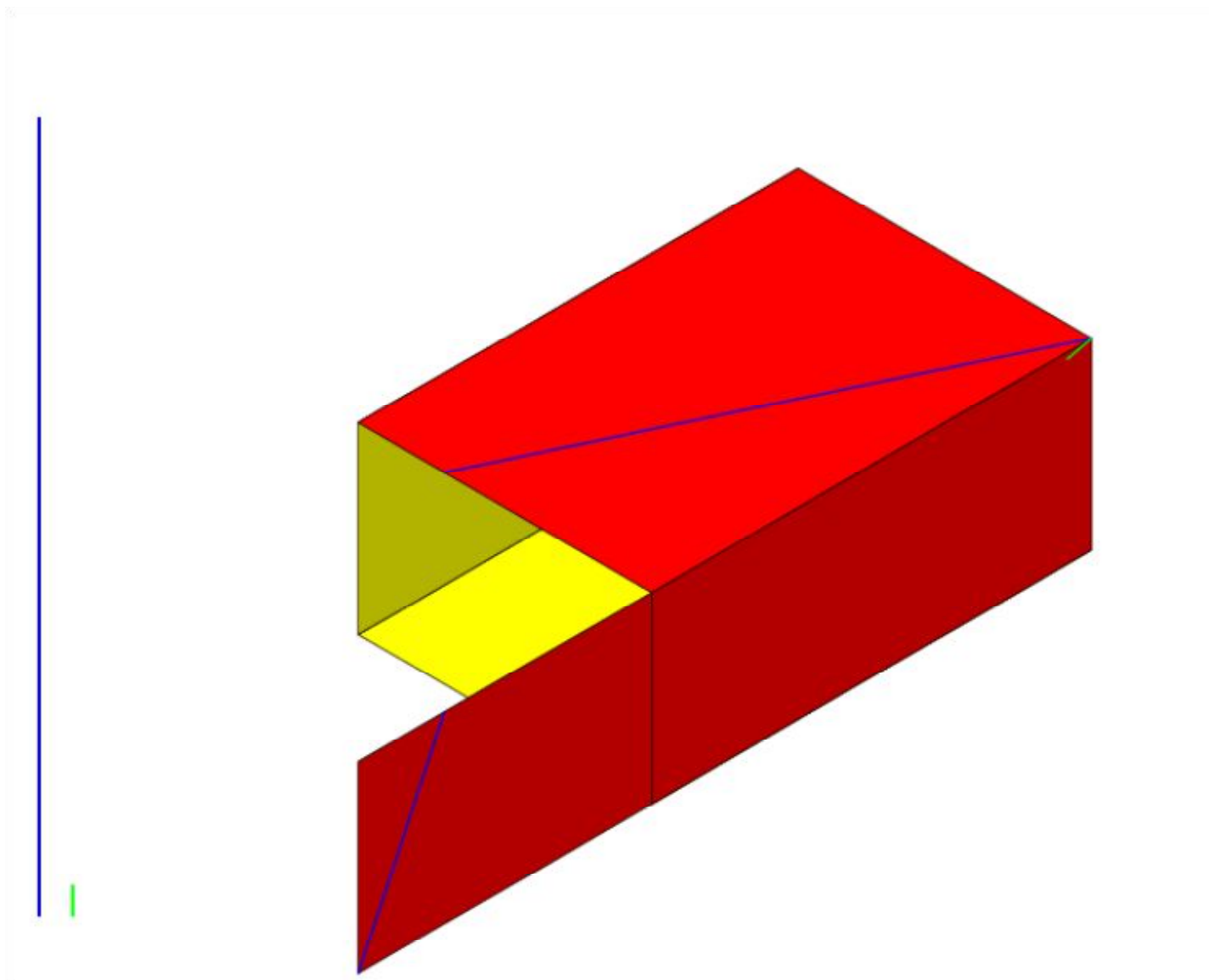

# La fourmi sur la caisse

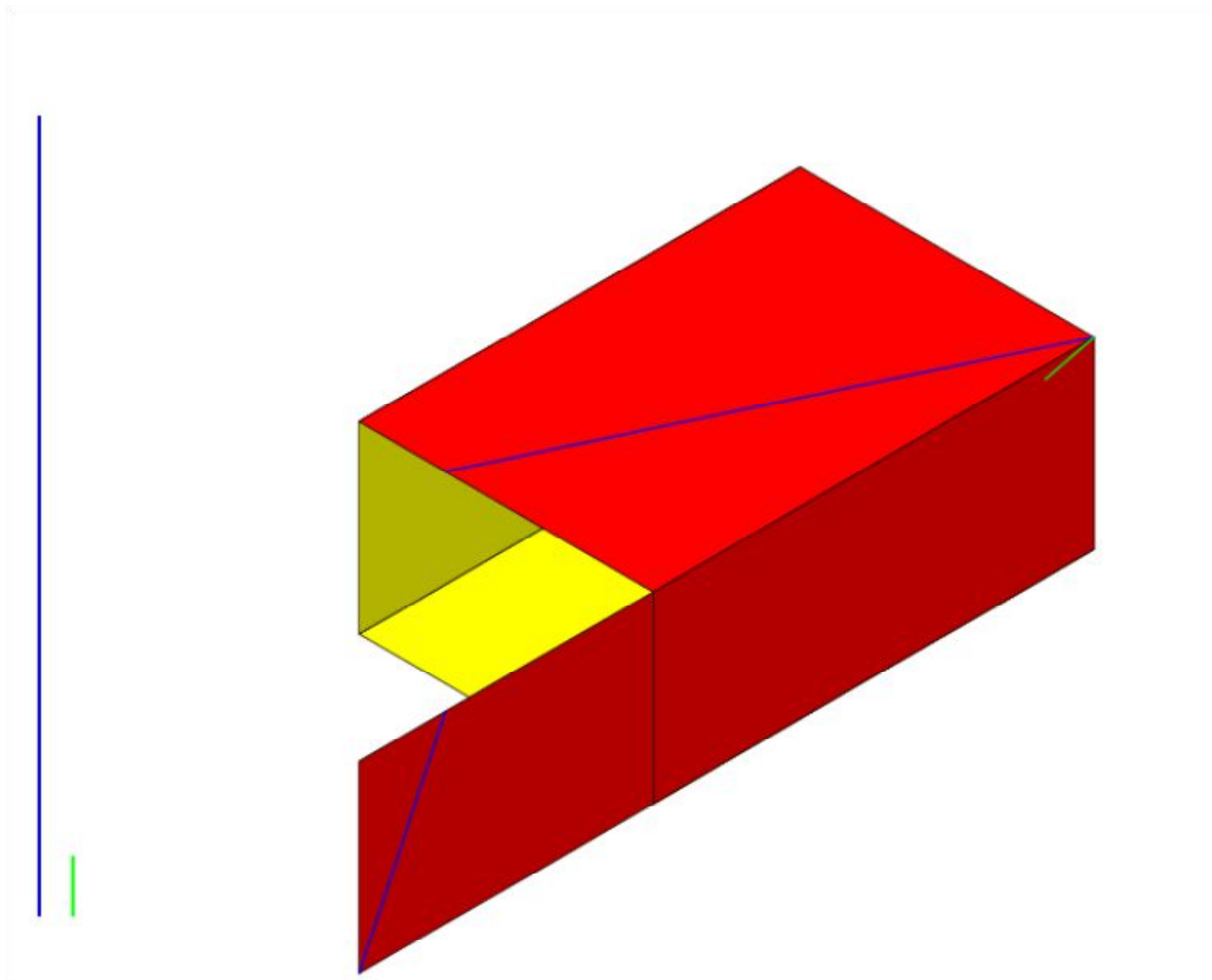

# La fourmi sur la caisse

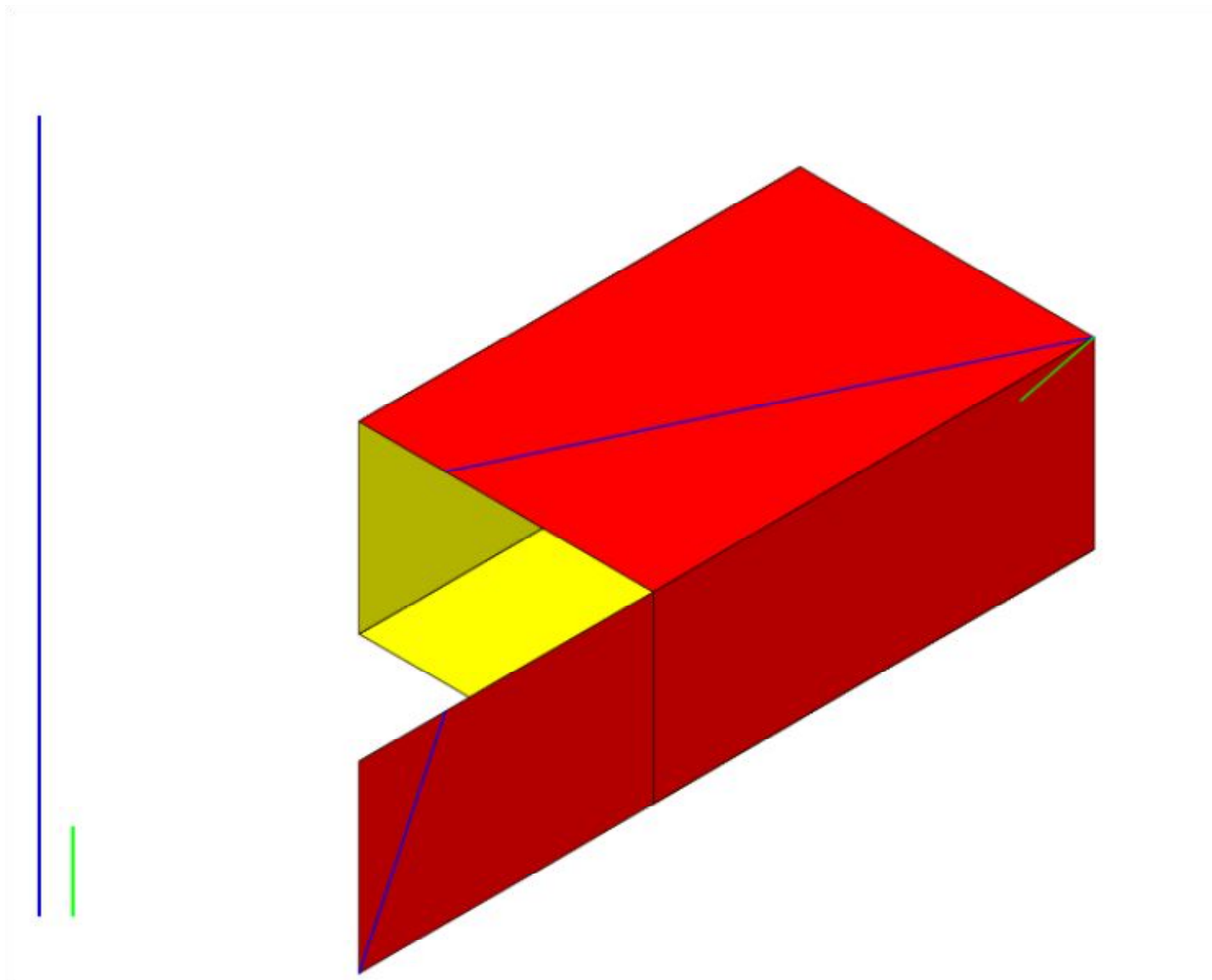

# La fourmi sur la caisse

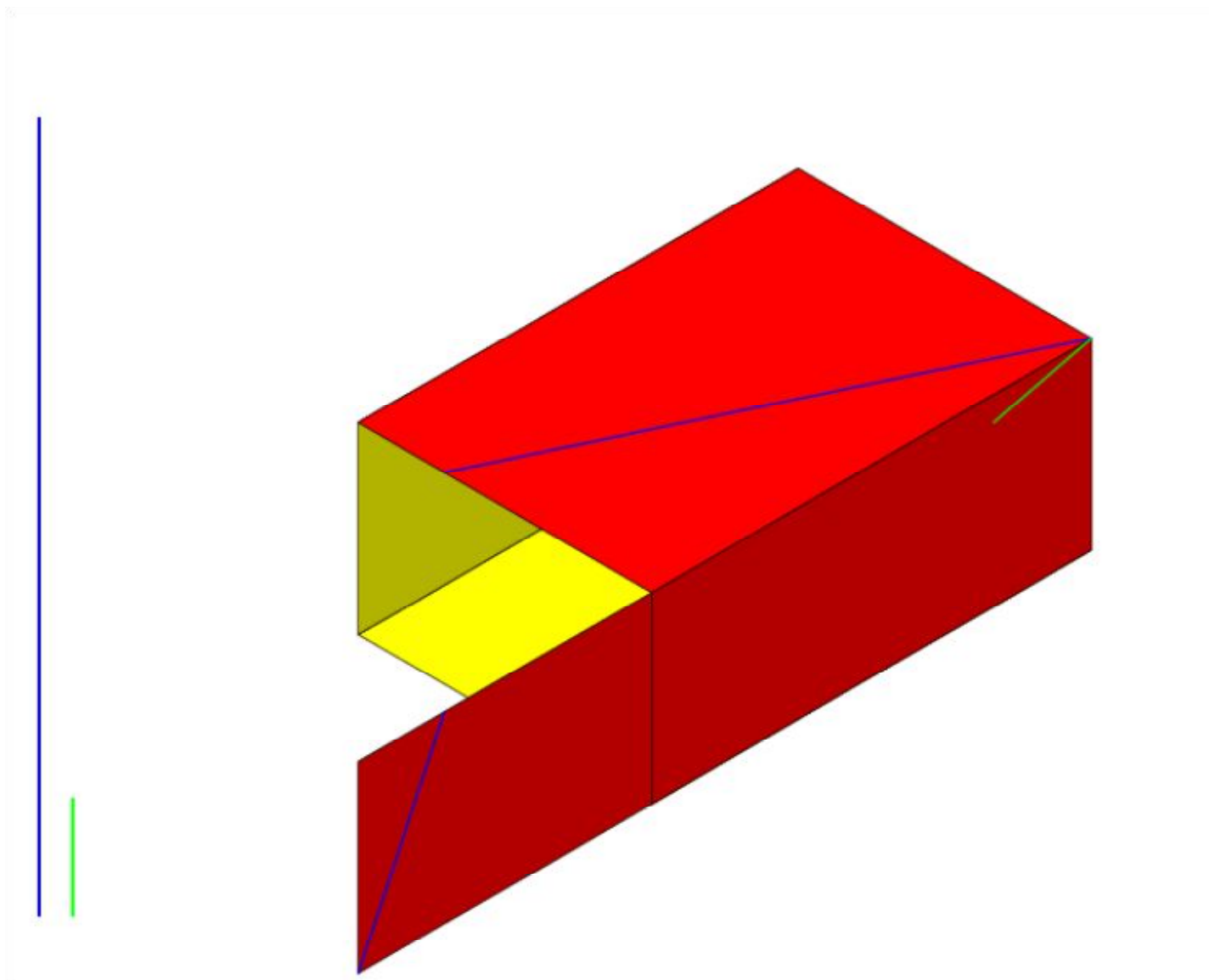

# La fourmi sur la caisse

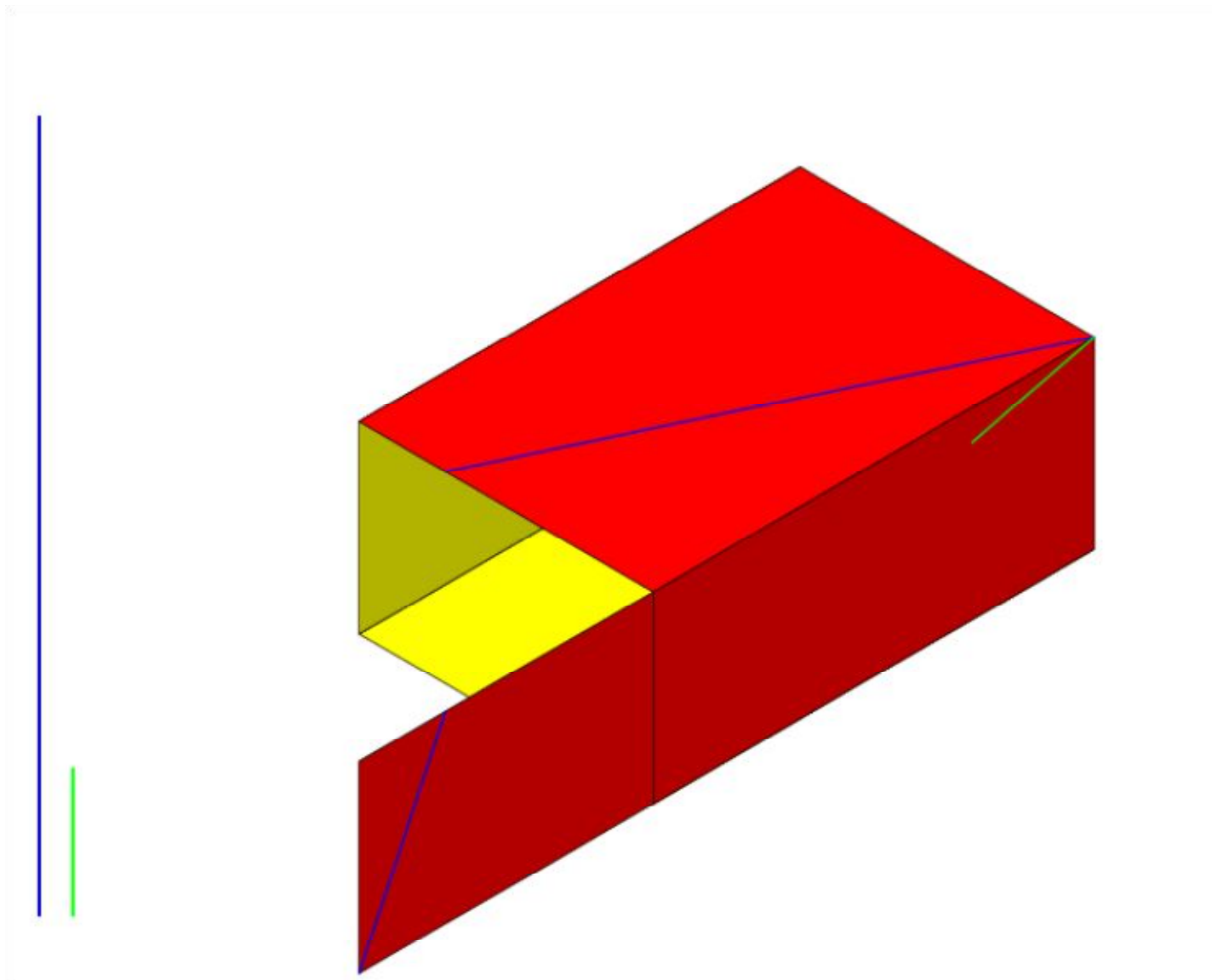

# La fourmi sur la caisse

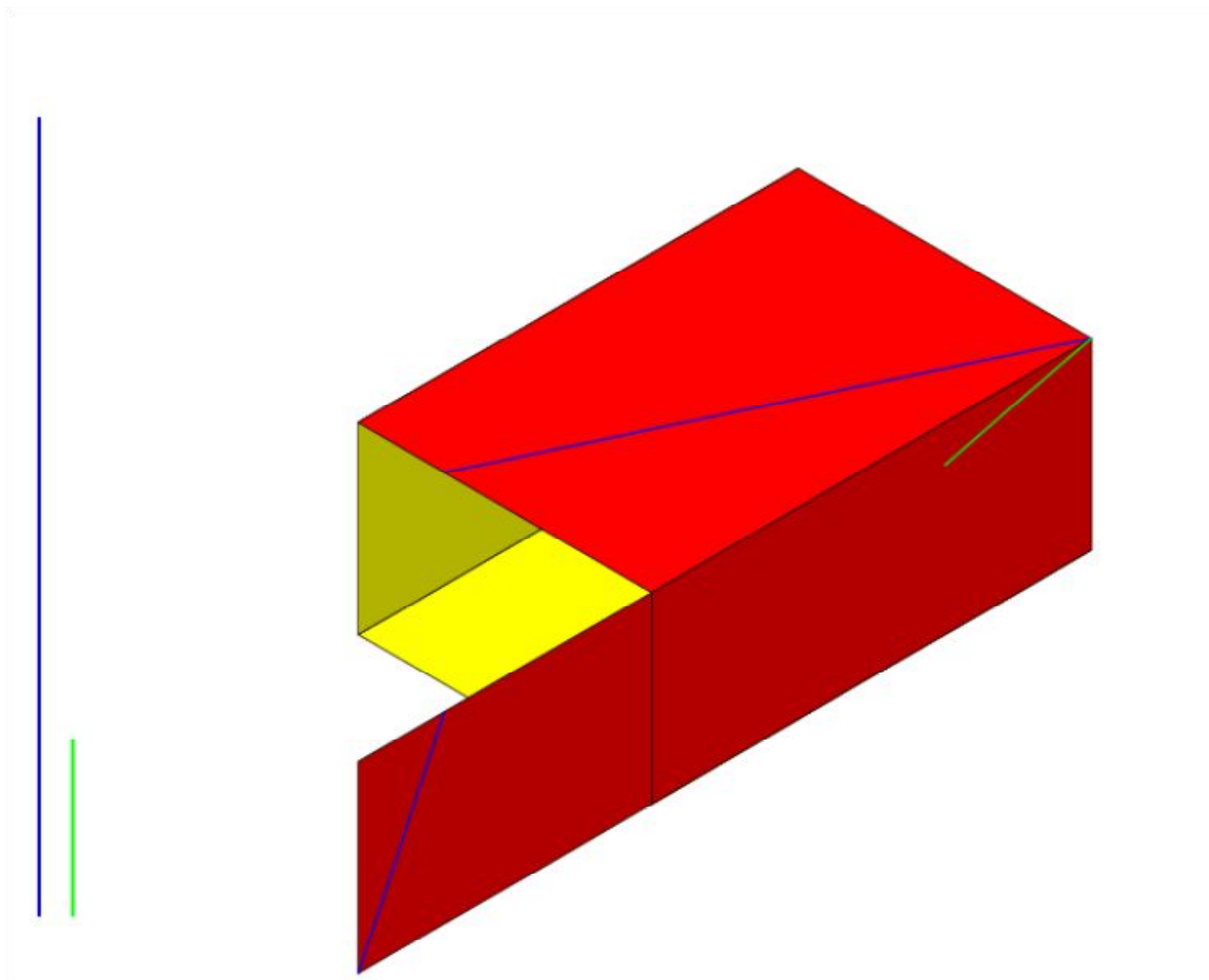

# La fourmi sur la caisse

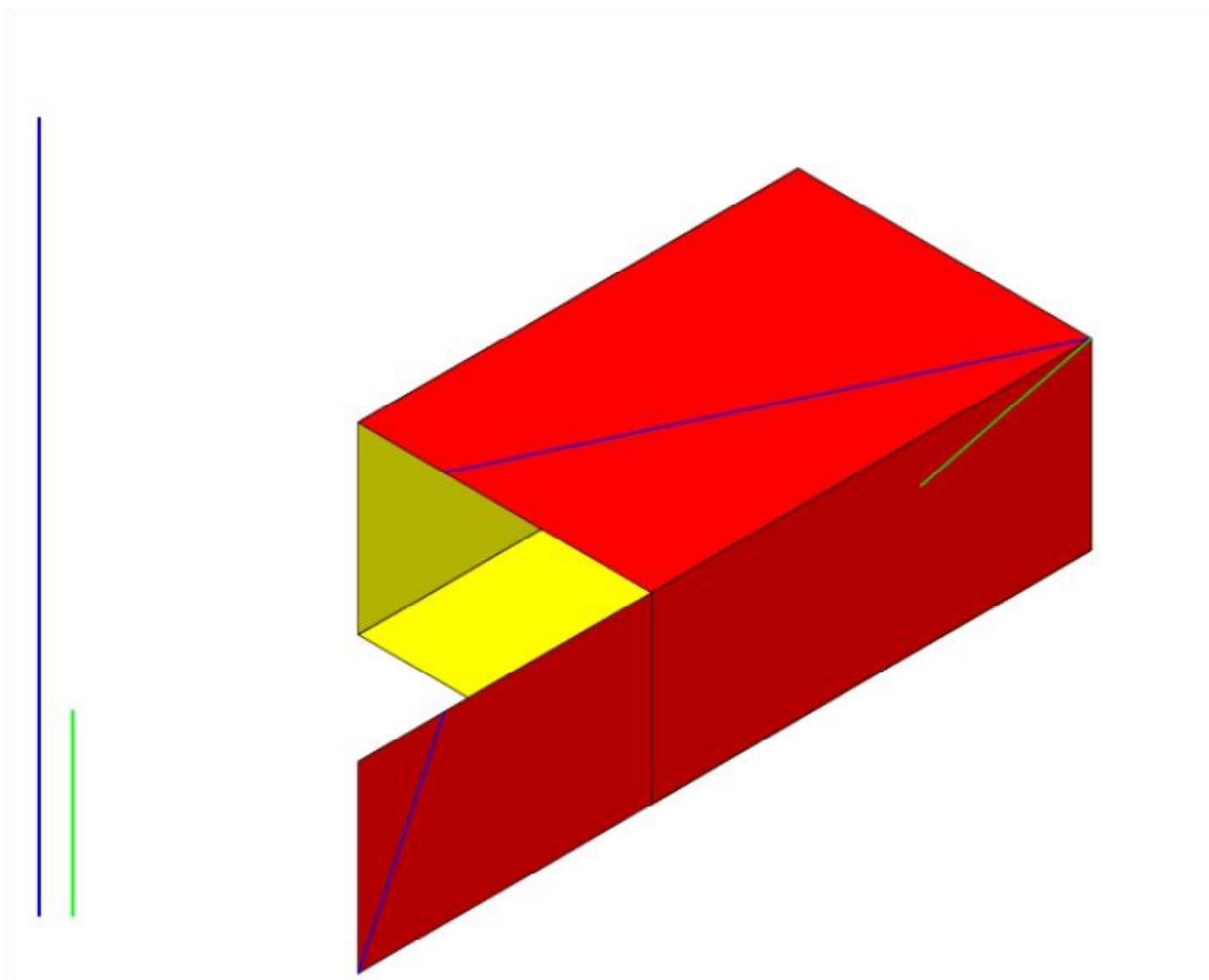



# La fourmi sur la caisse

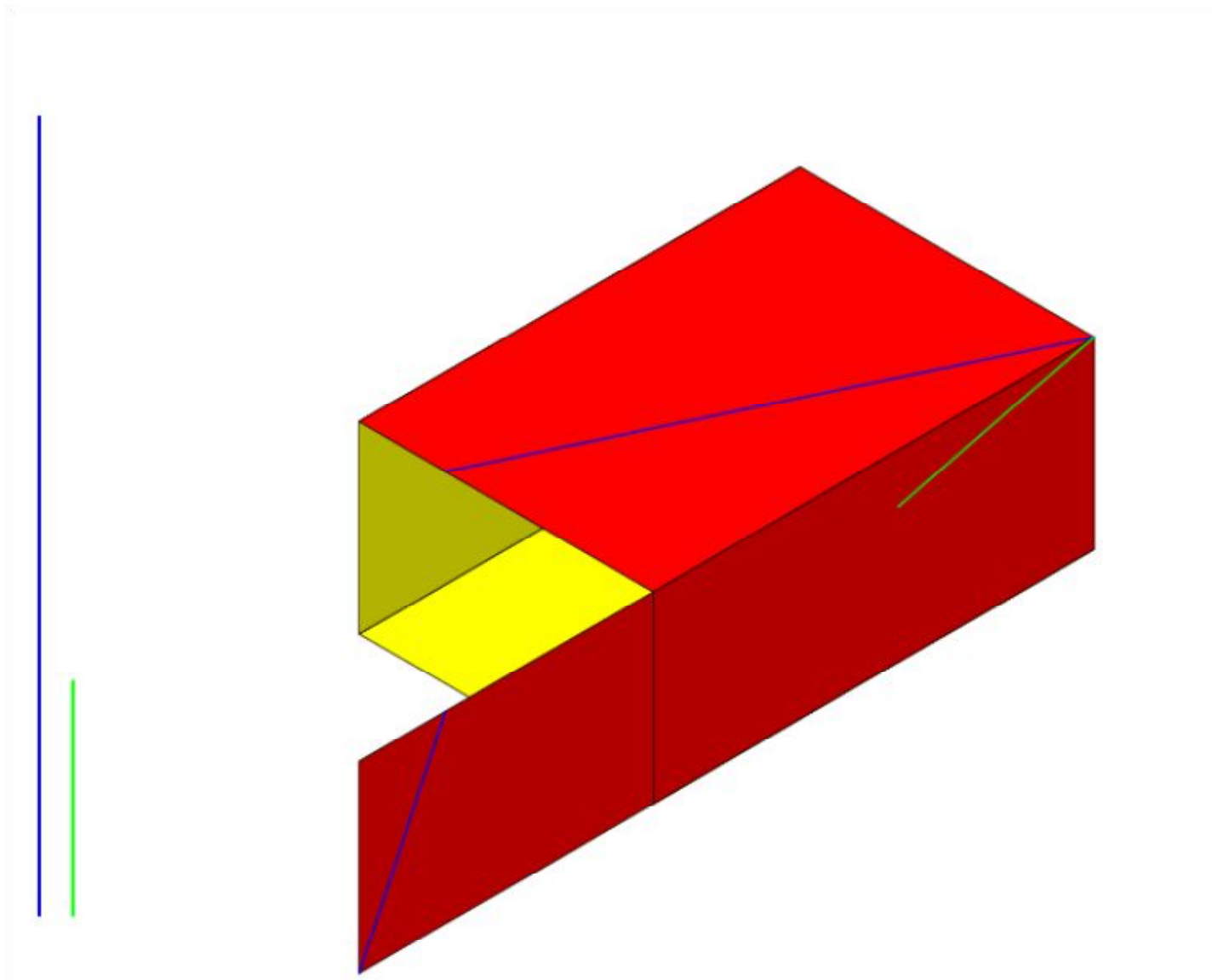

# La fourmi sur la caisse

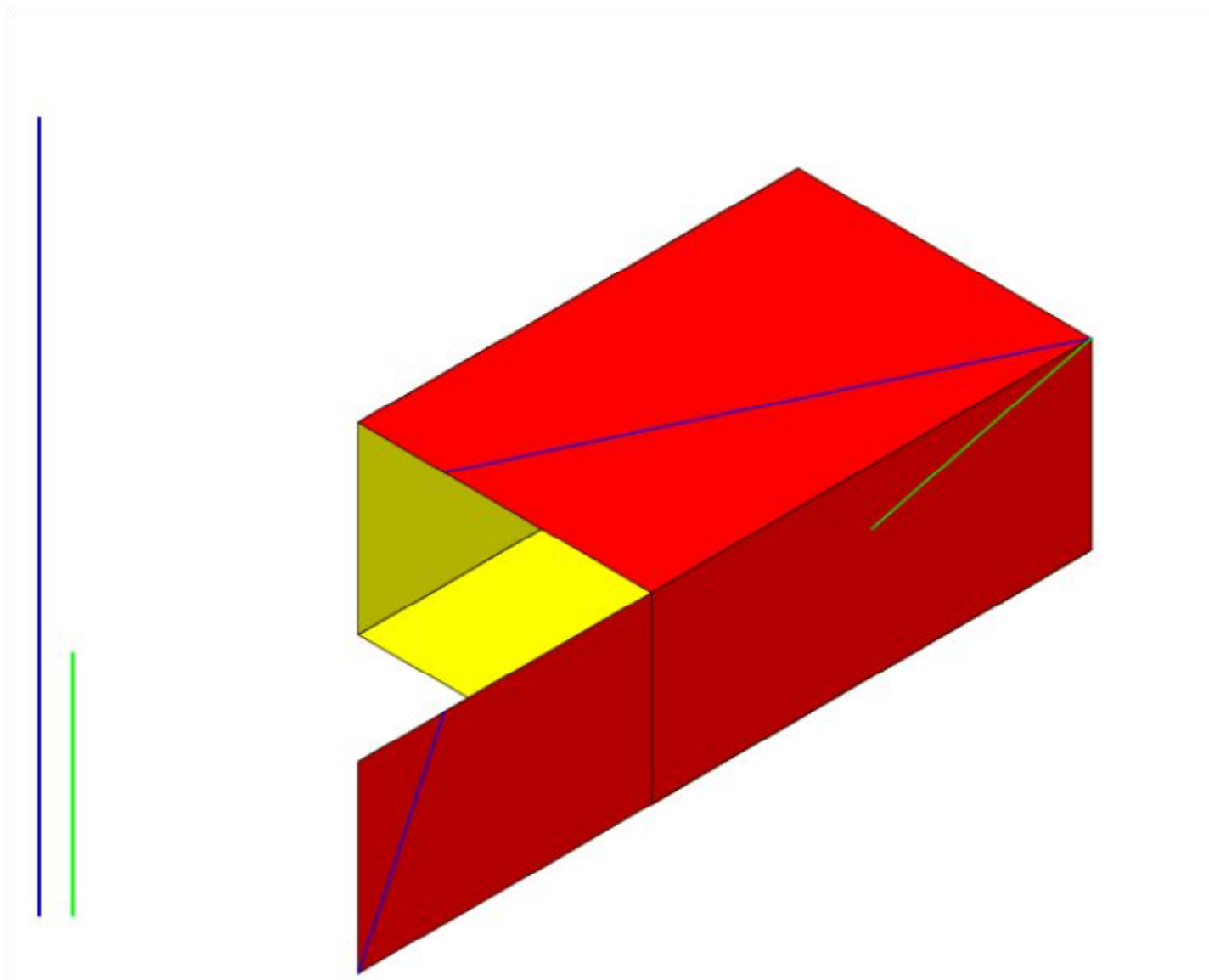

# La fourmi sur la caisse

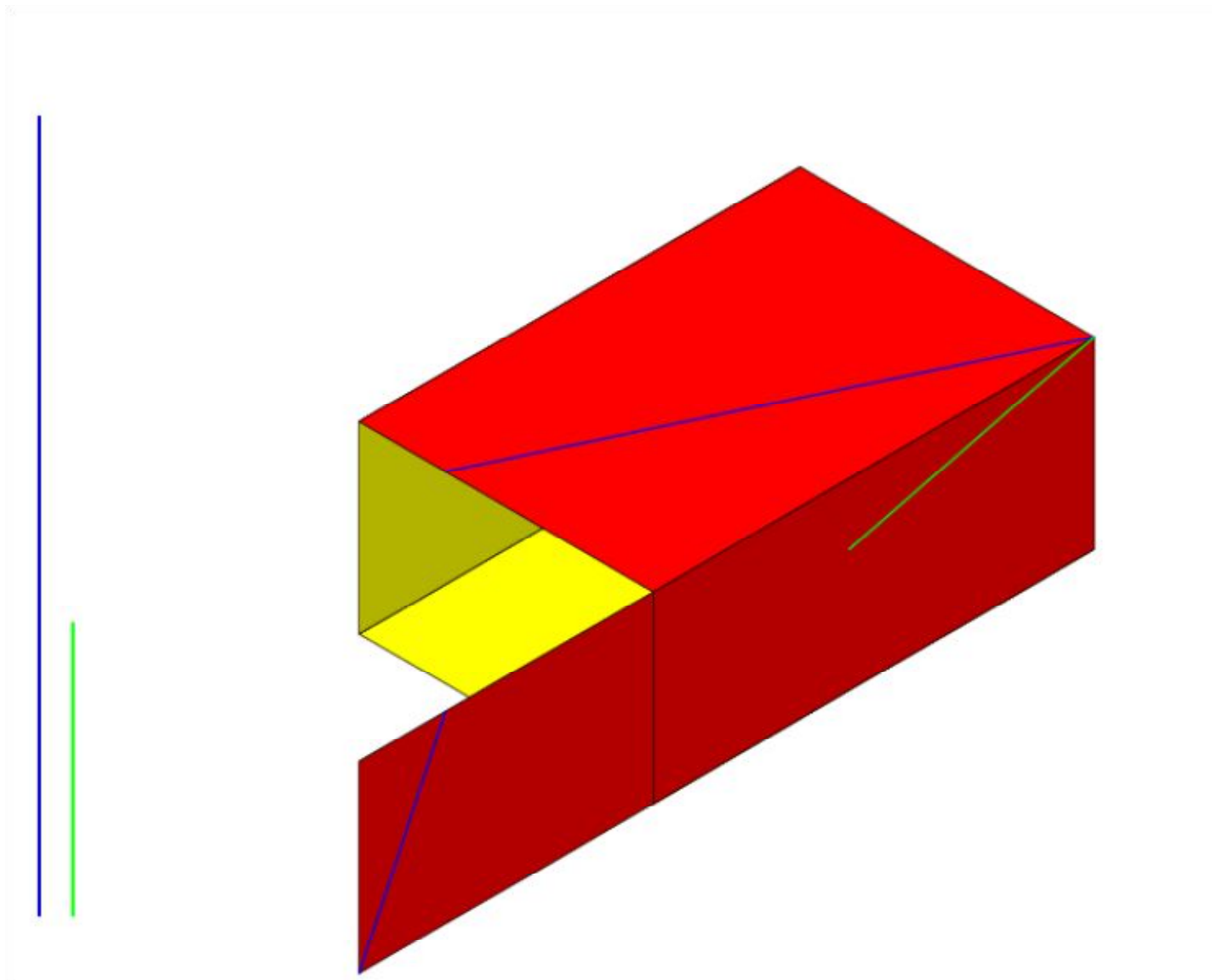

# La fourmi sur la caisse

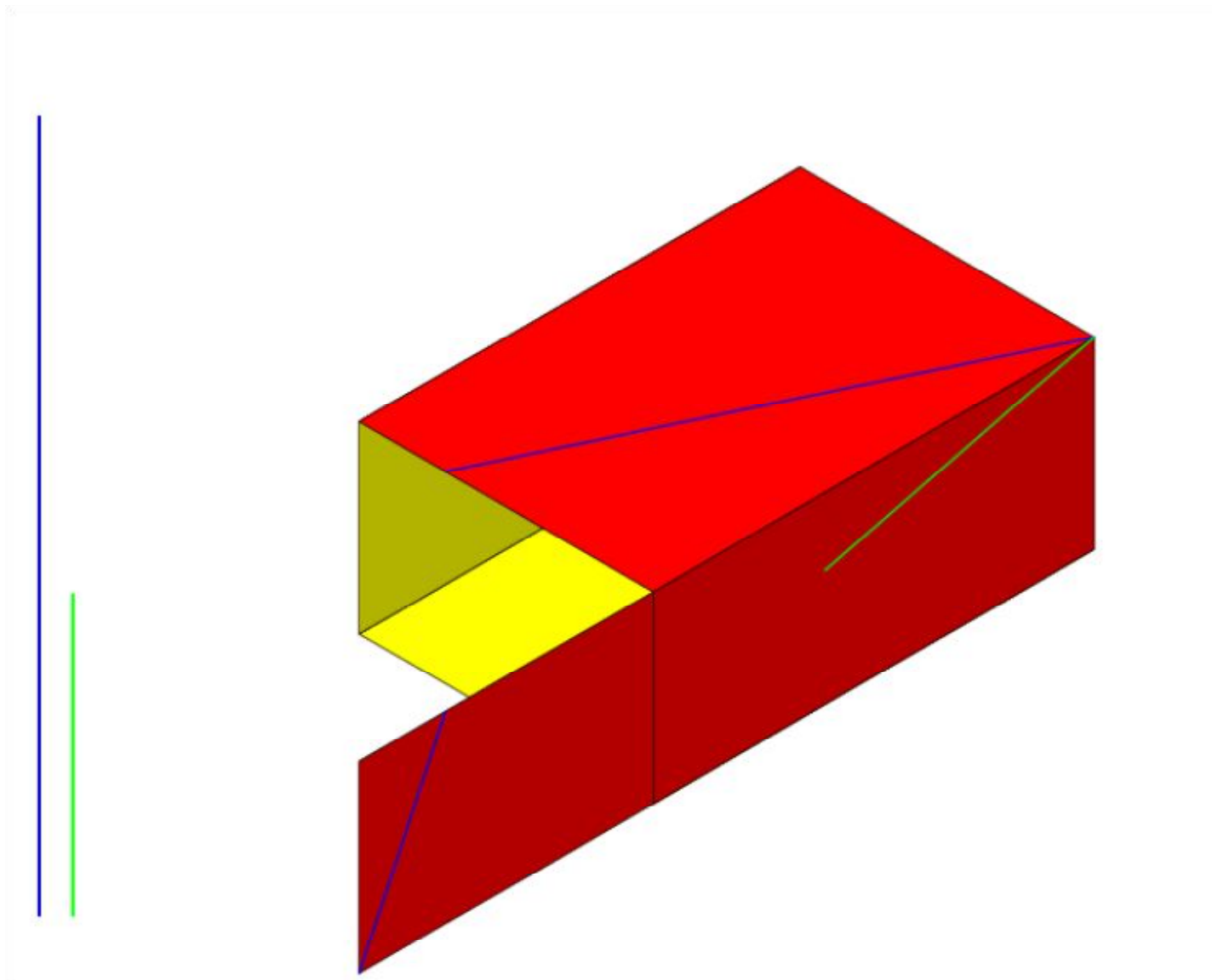

# La fourmi sur la caisse

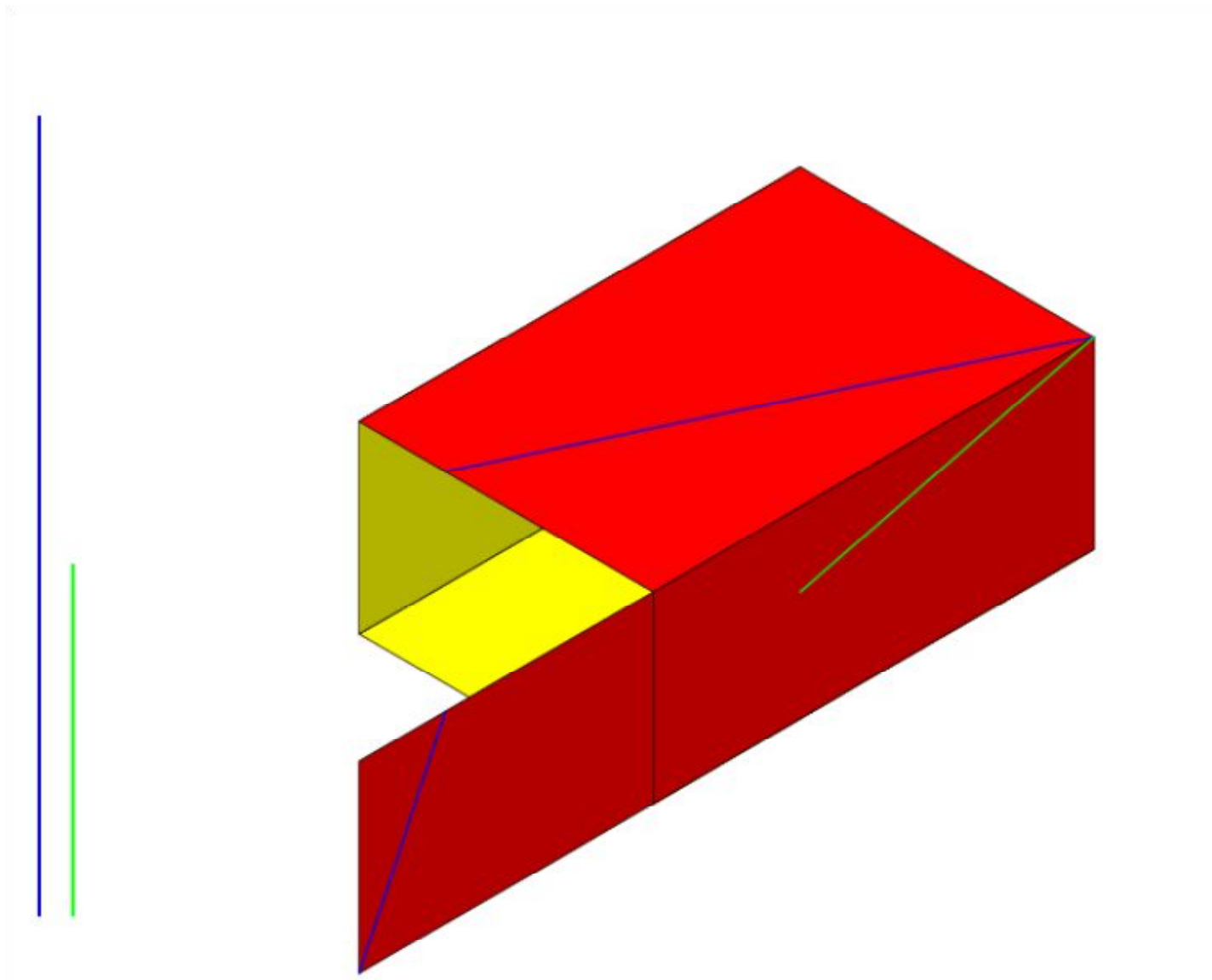

# La fourmi sur la caisse

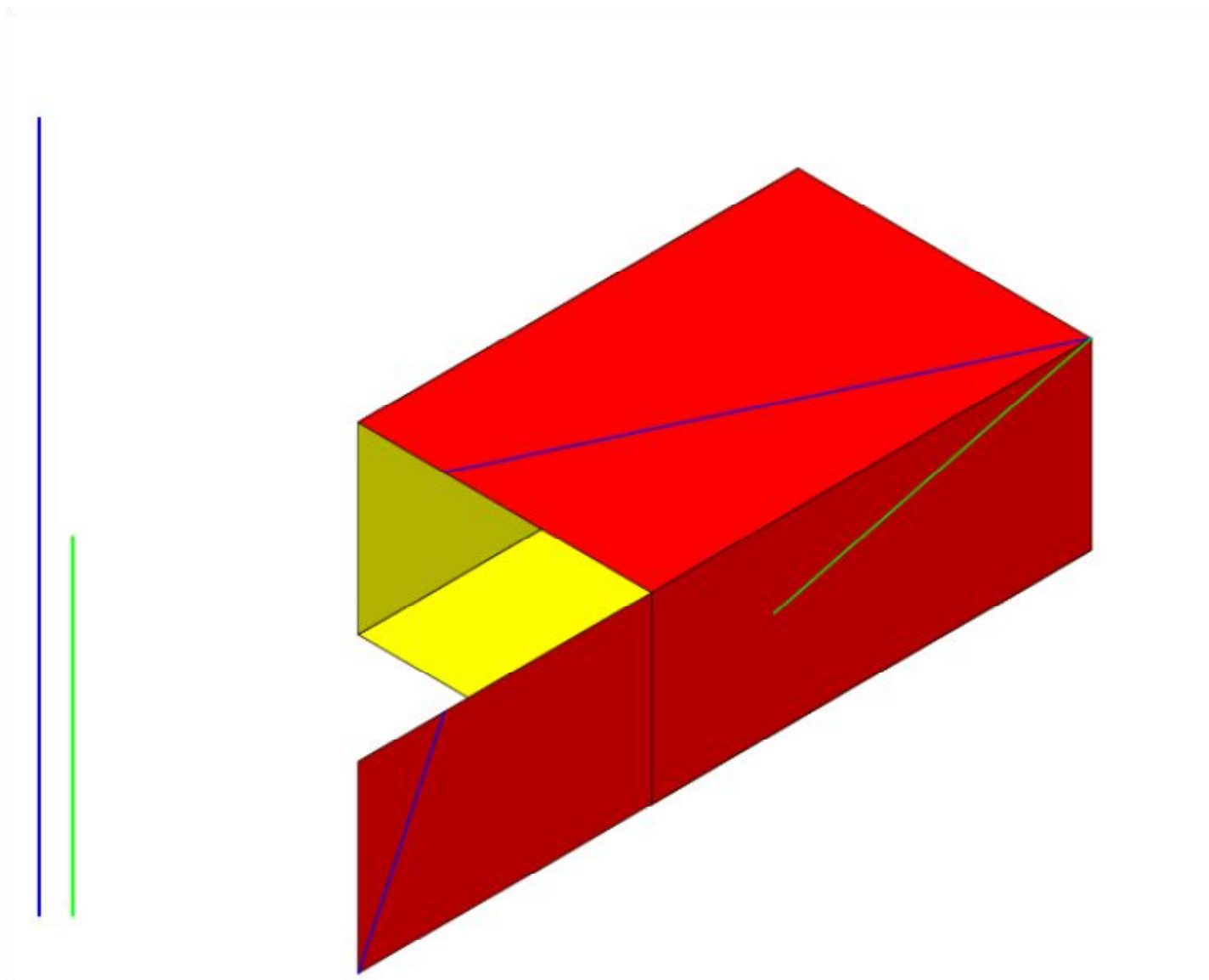

# La fourmi sur la caisse

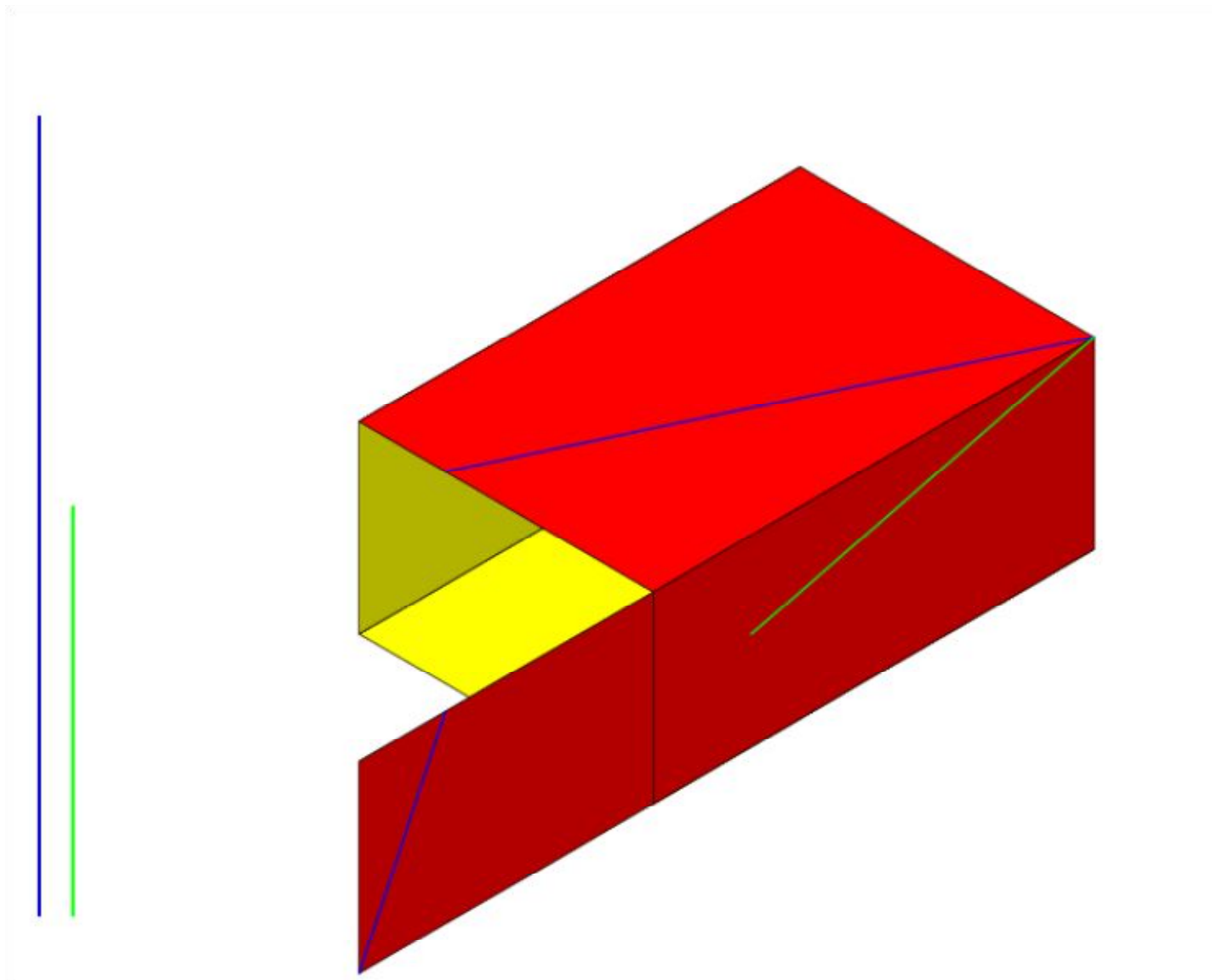

# La fourmi sur la caisse

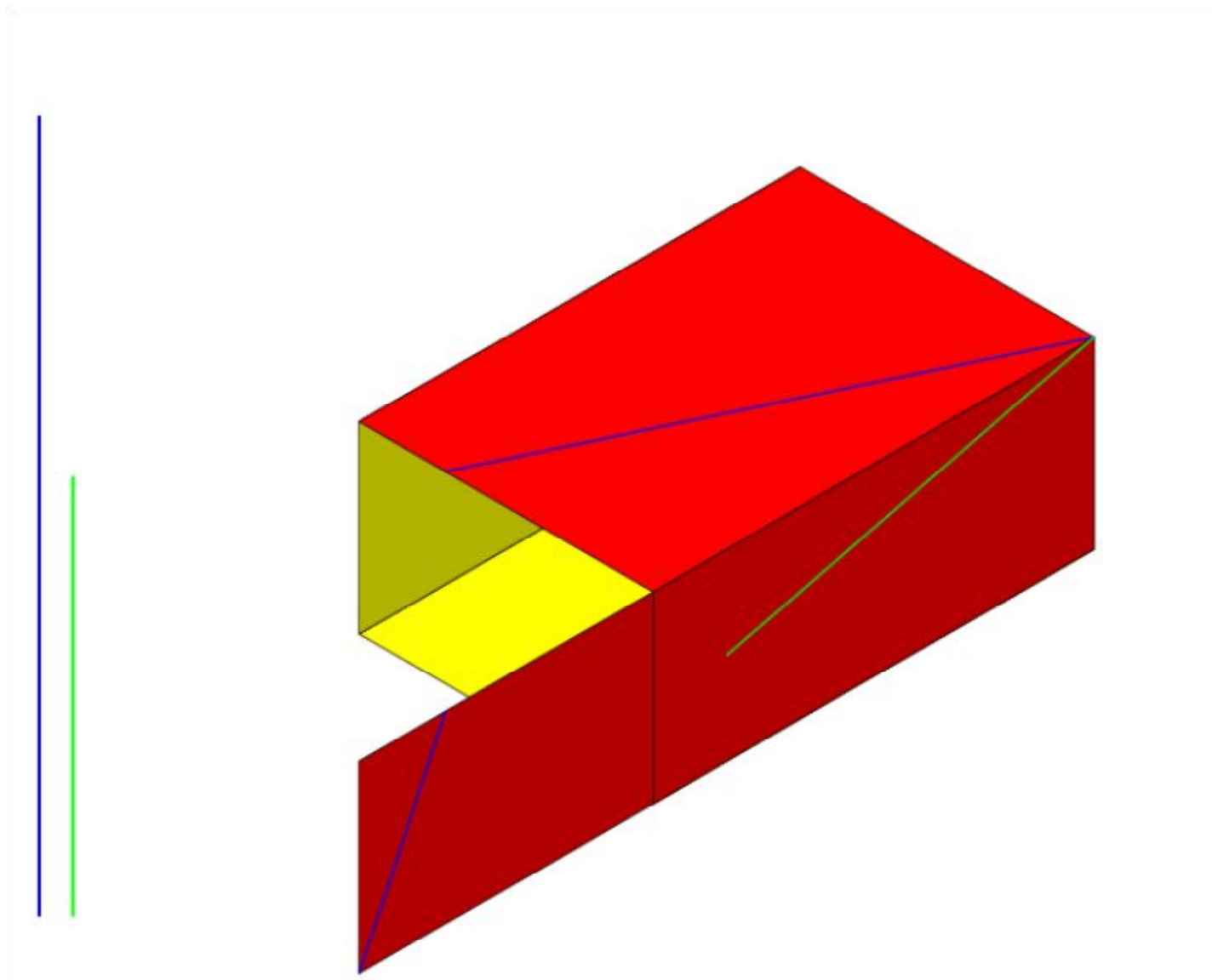



# La fourmi sur la caisse

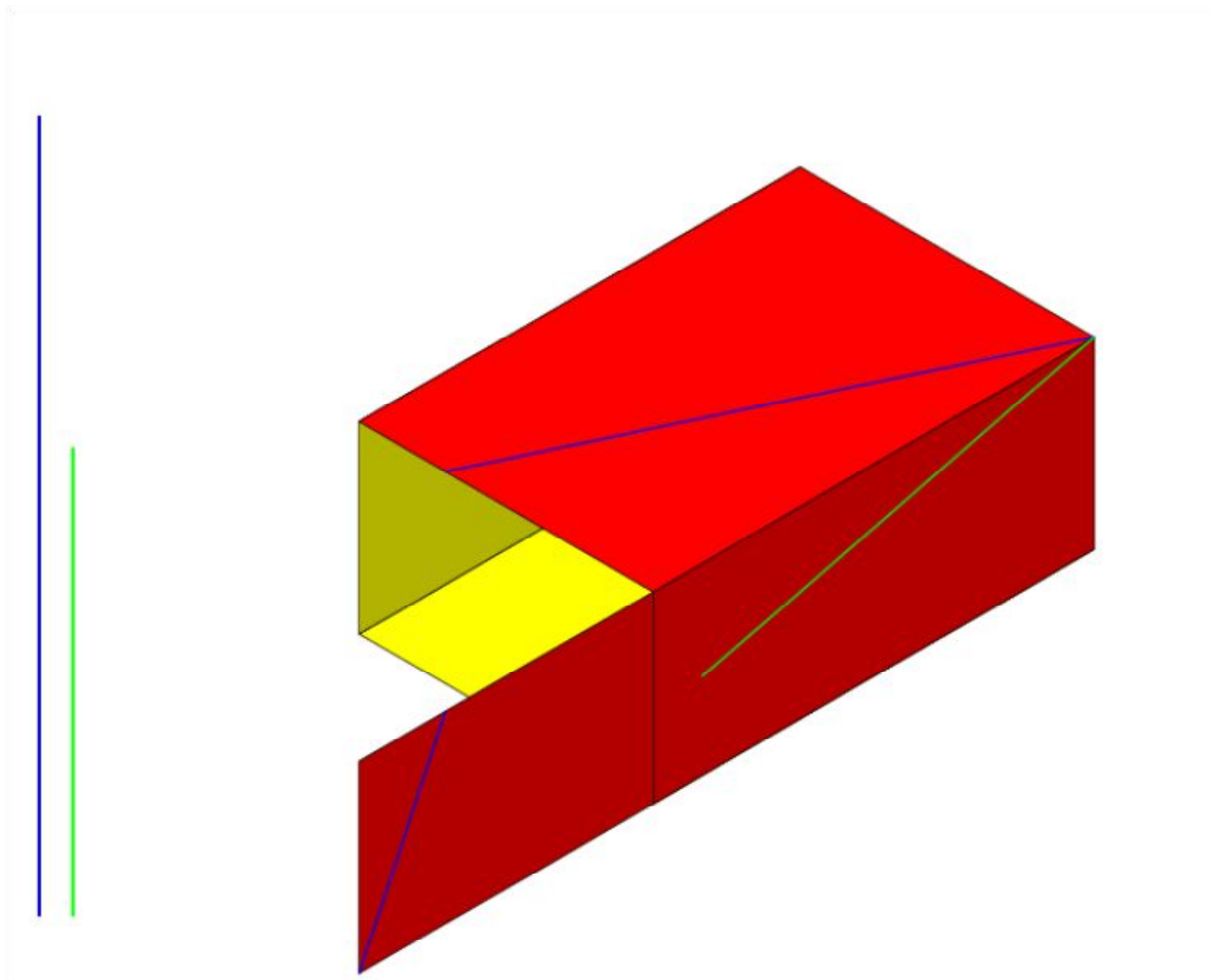

# La fourmi sur la caisse

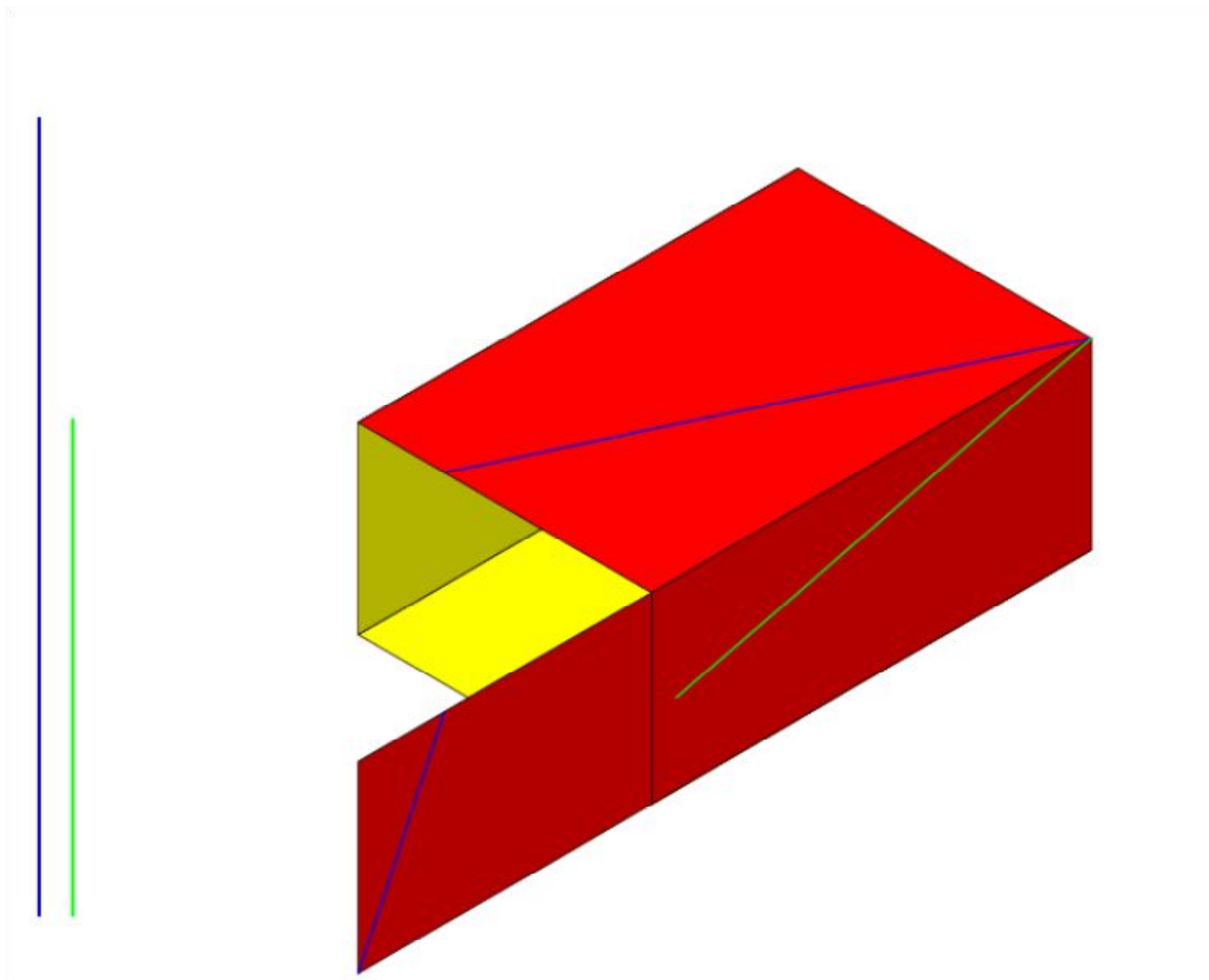

# La fourmi sur la caisse

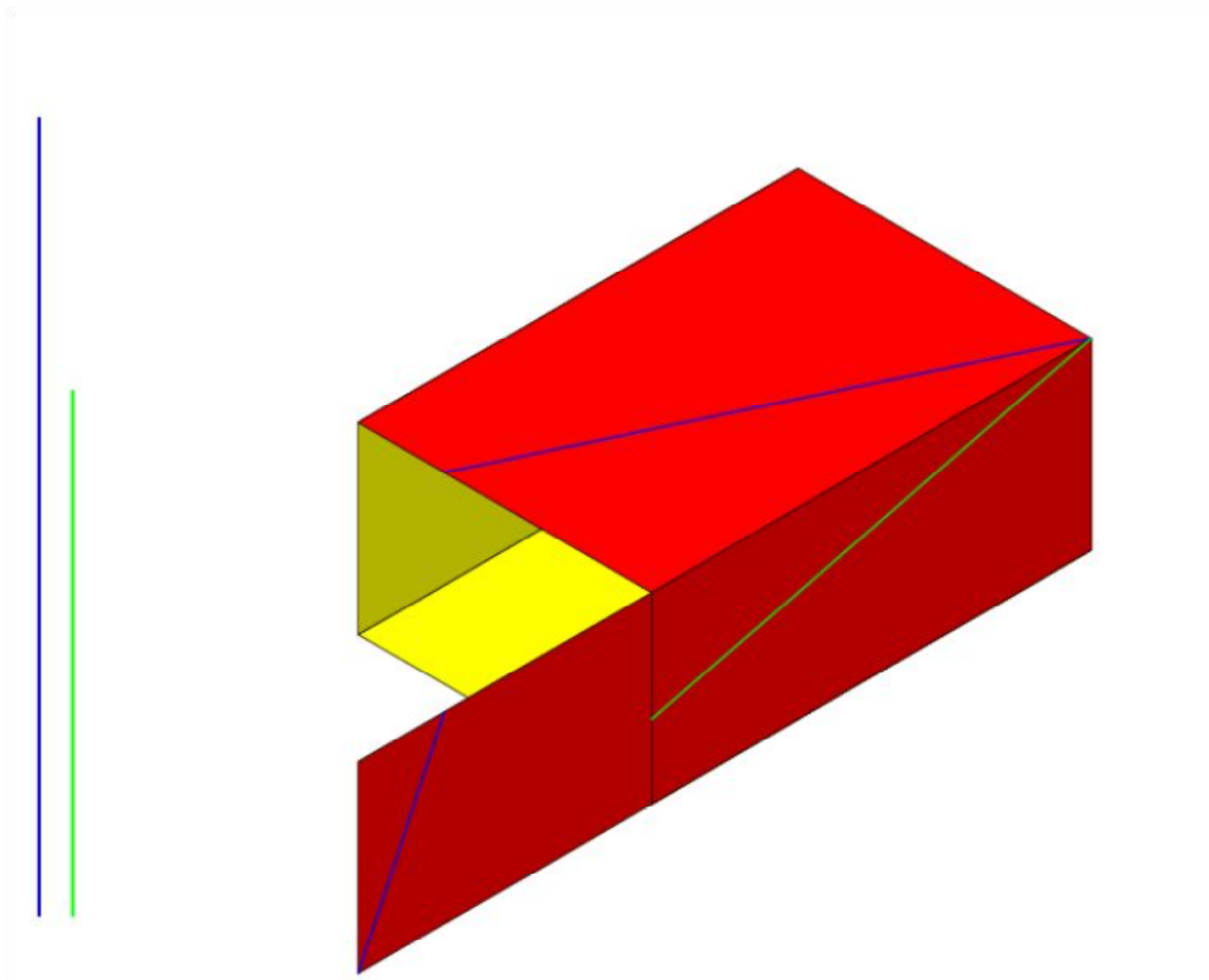

# La fourmi sur la caisse

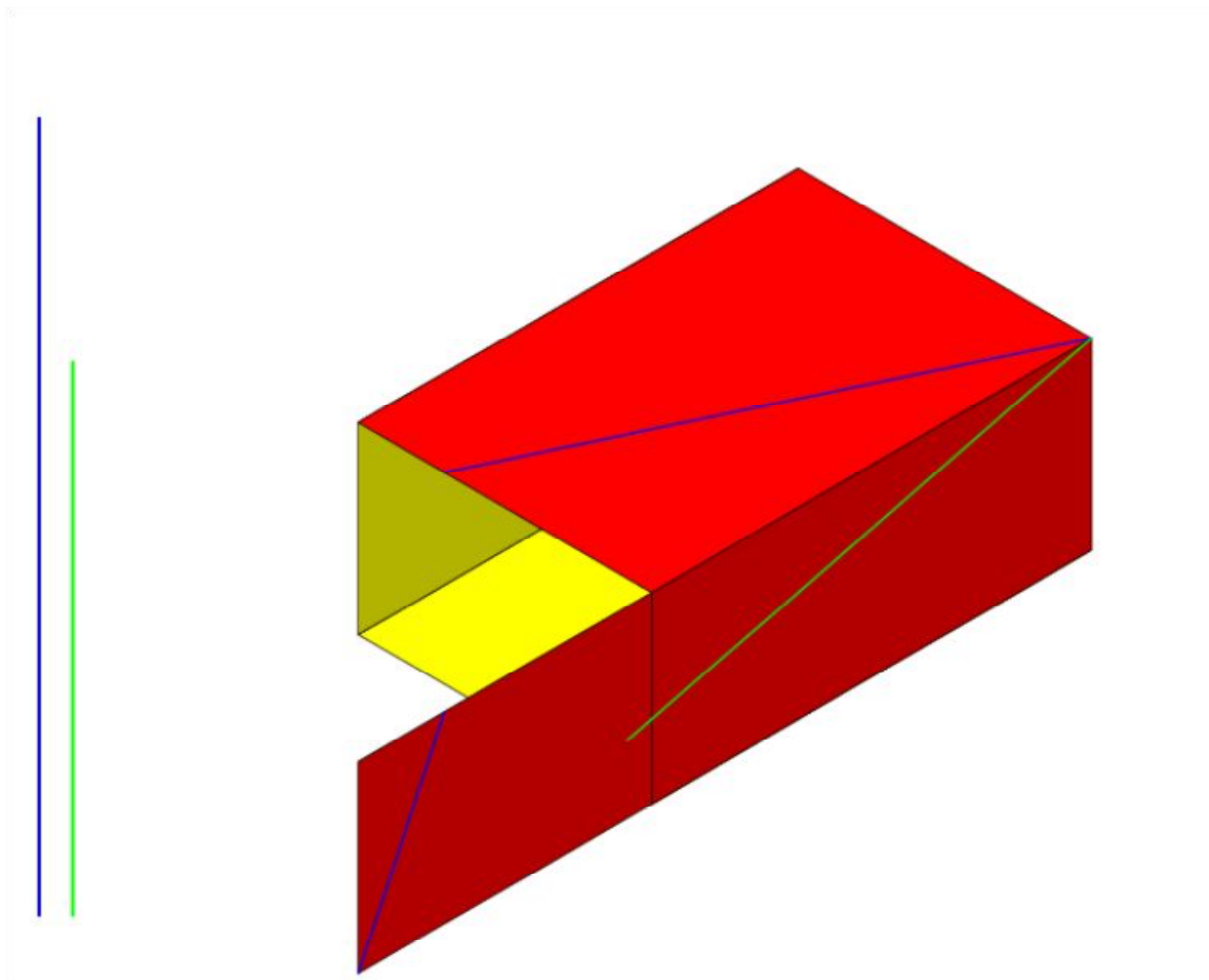

# La fourmi sur la caisse

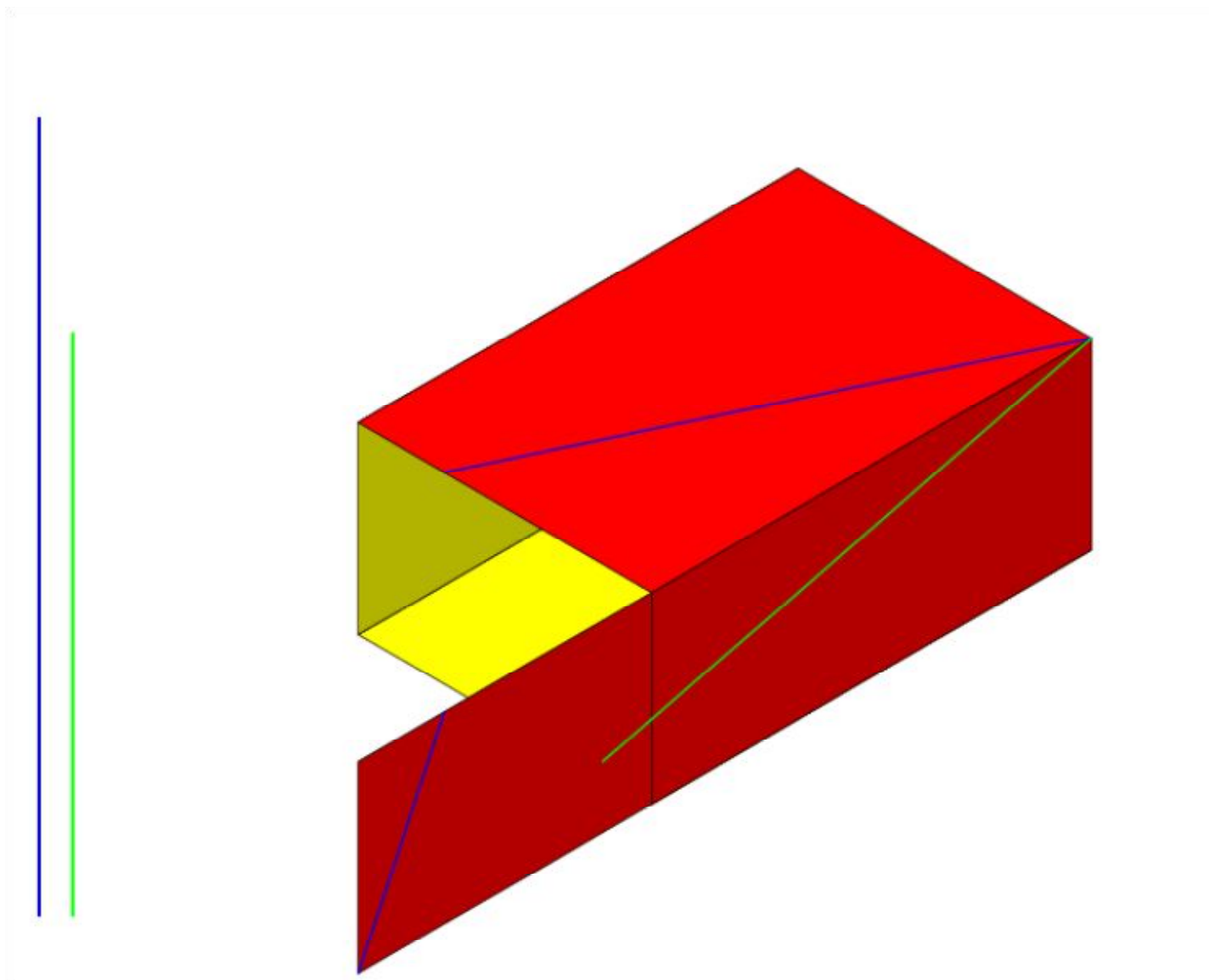

# La fourmi sur la caisse

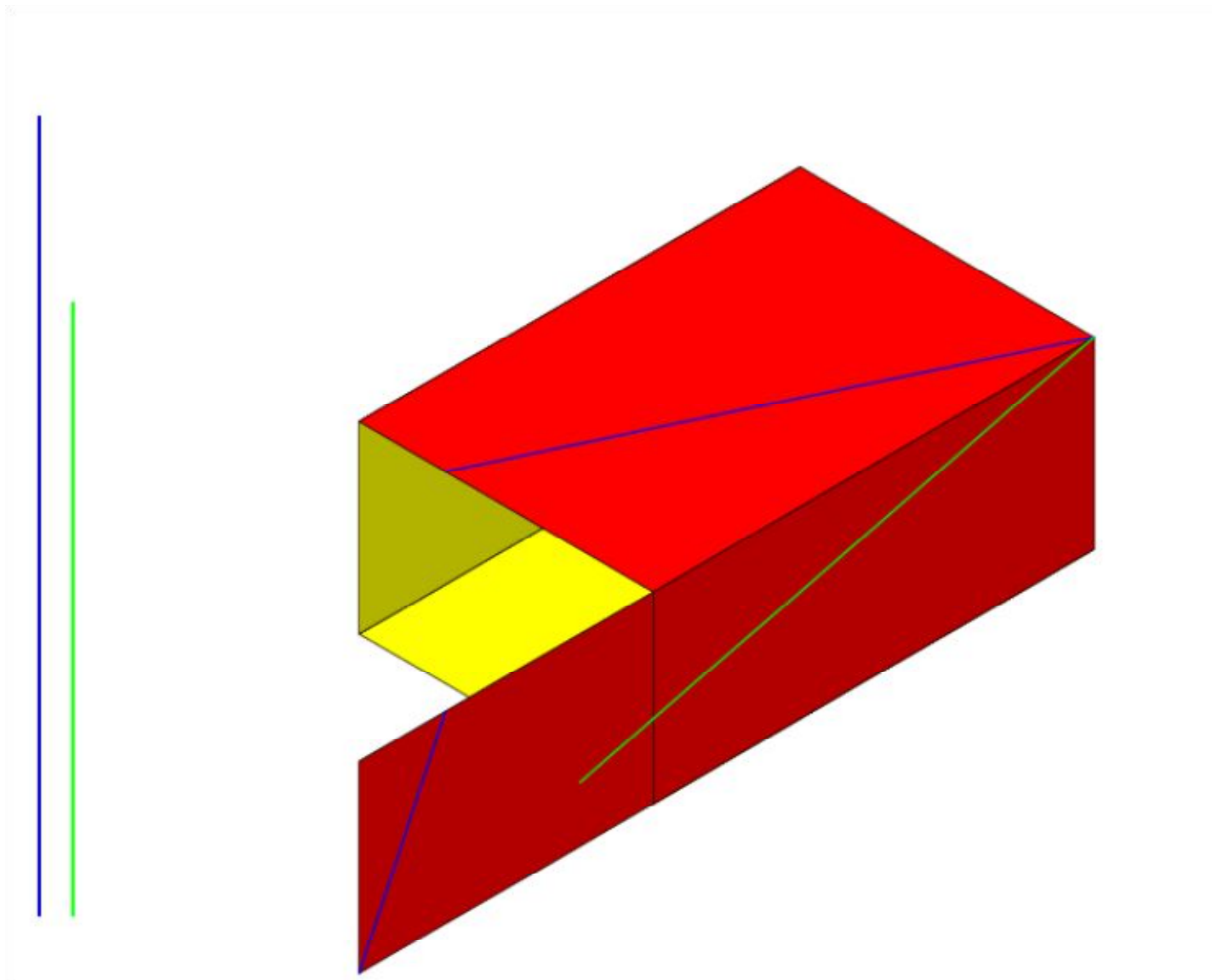

# La fourmi sur la caisse

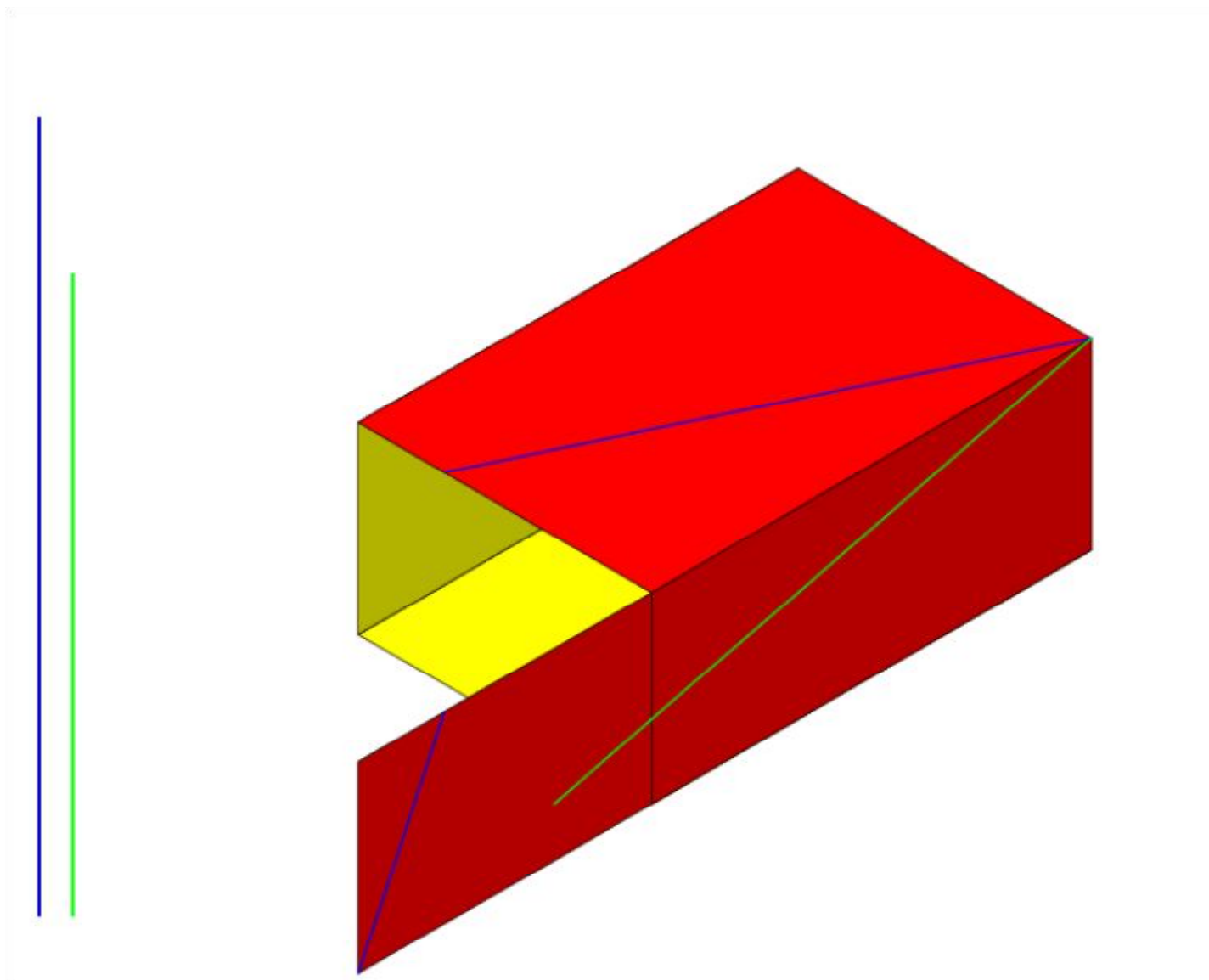

# La fourmi sur la caisse

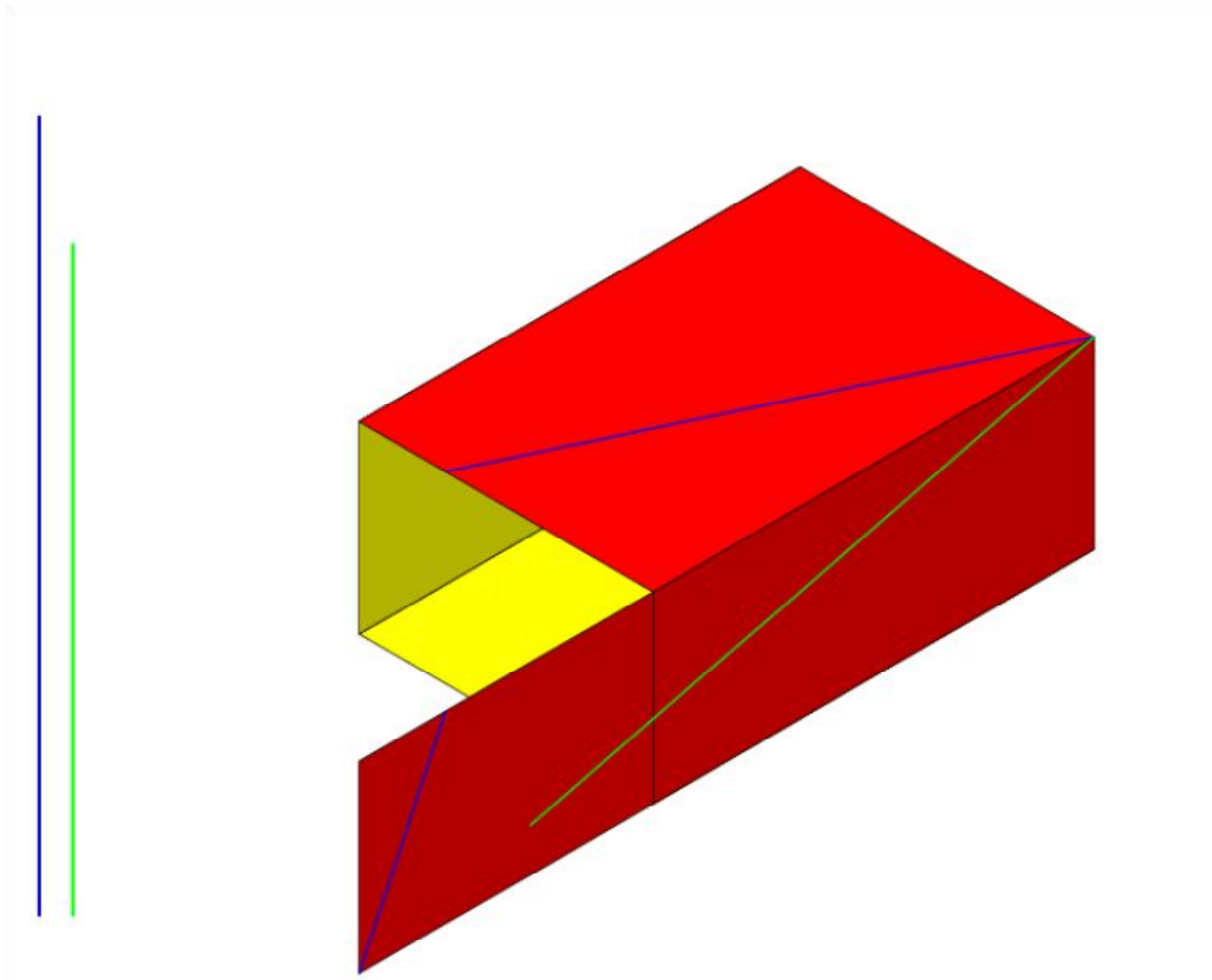



# La fourmi sur la caisse

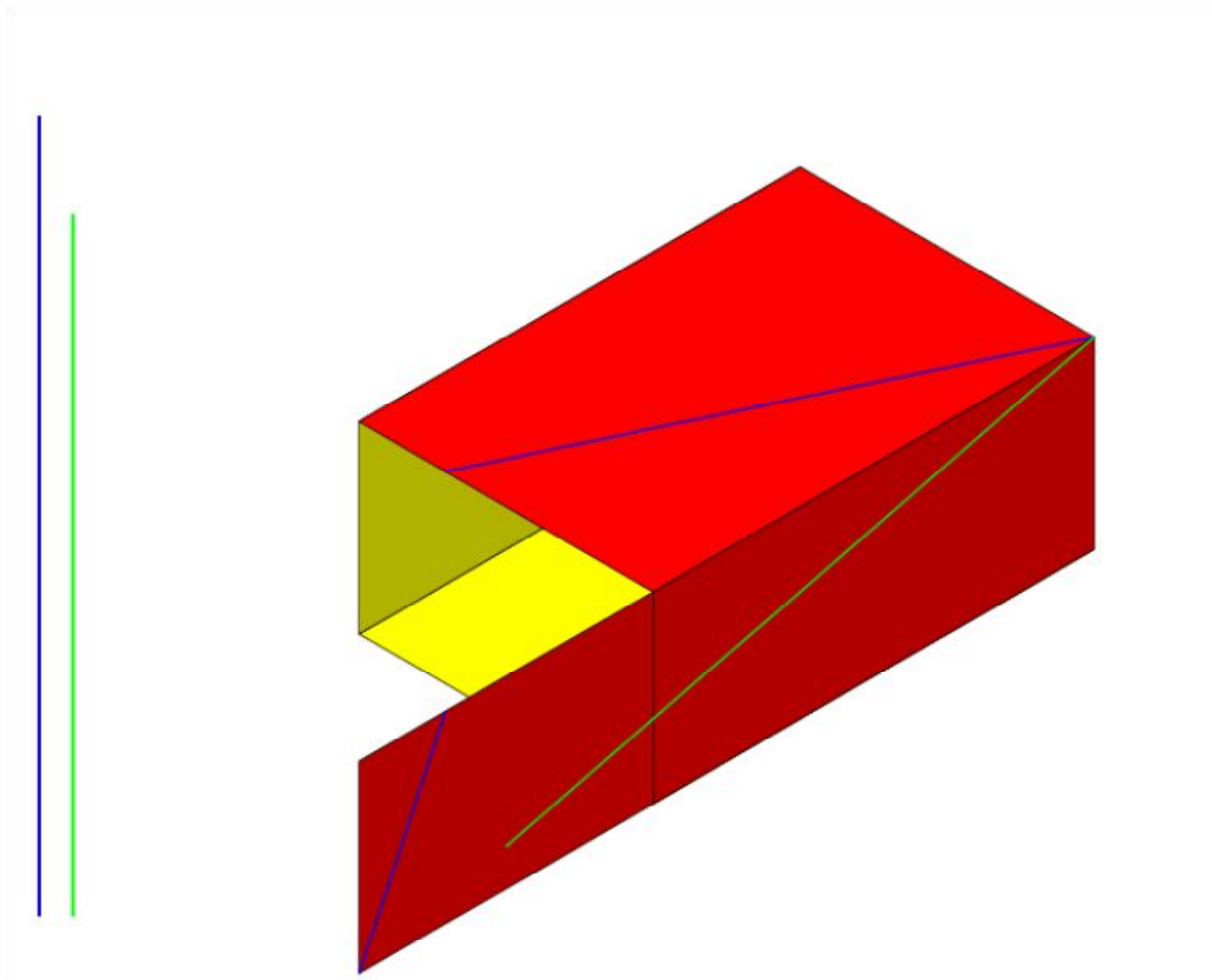

# La fourmi sur la caisse

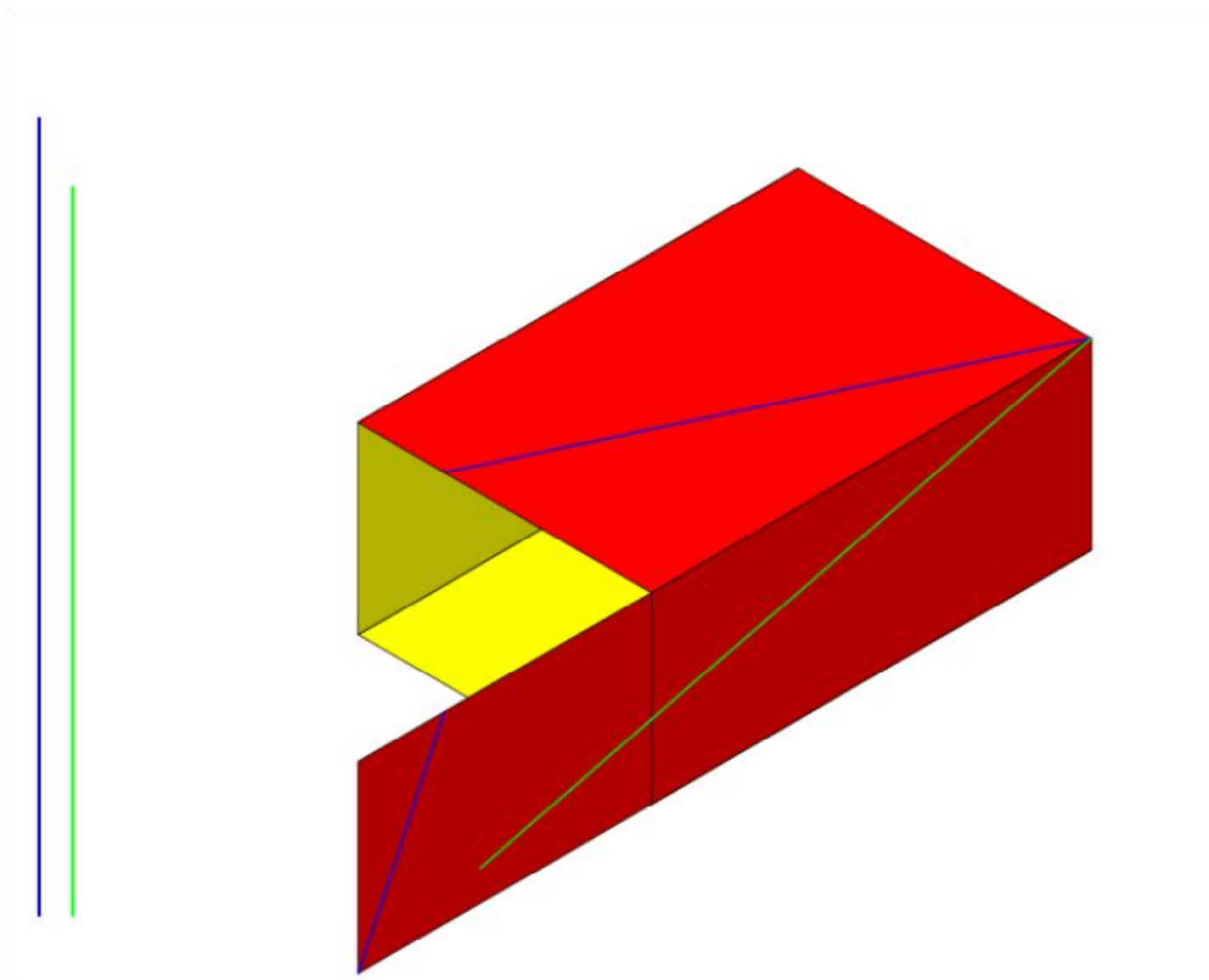

# La fourmi sur la caisse

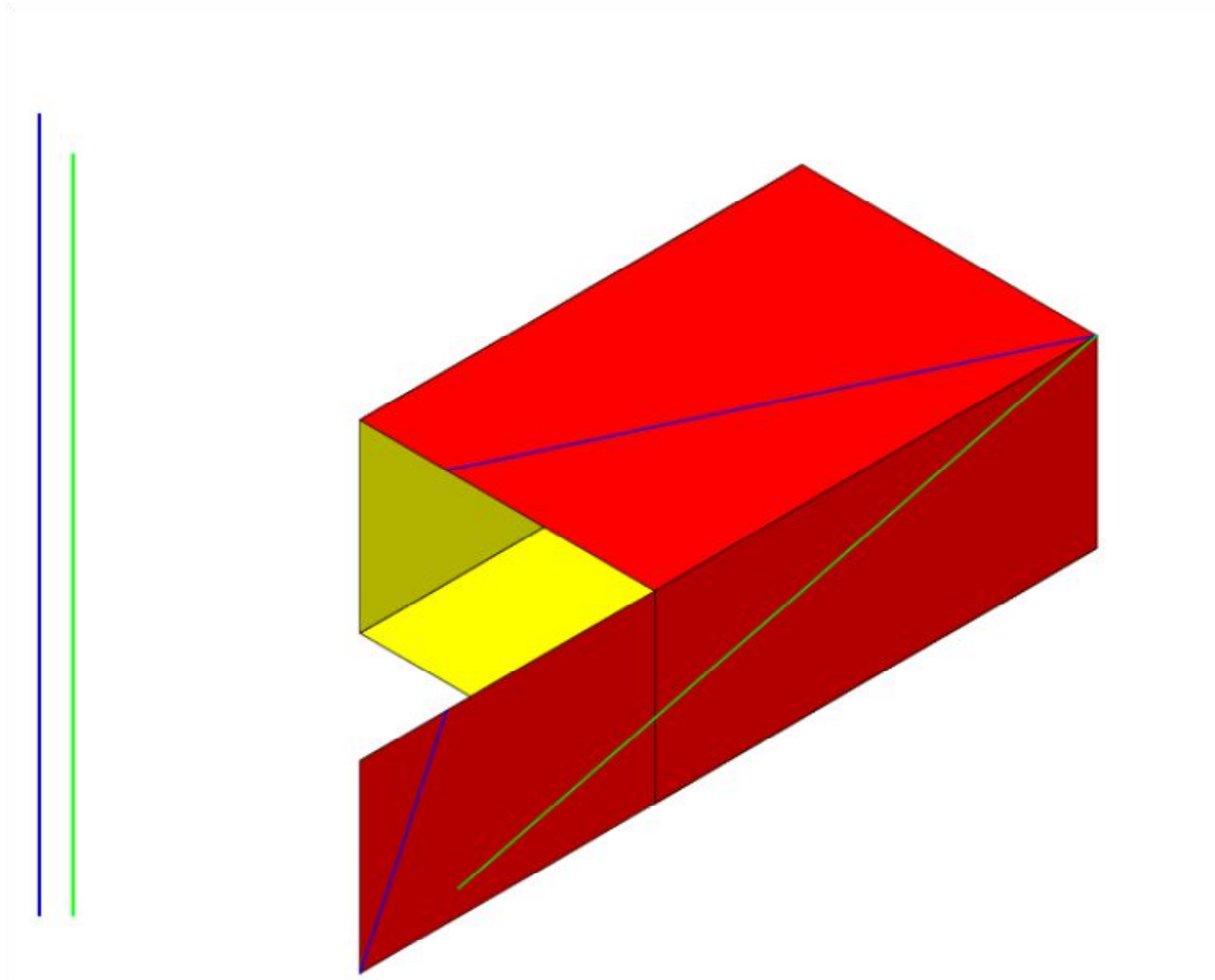

# La fourmi sur la caisse

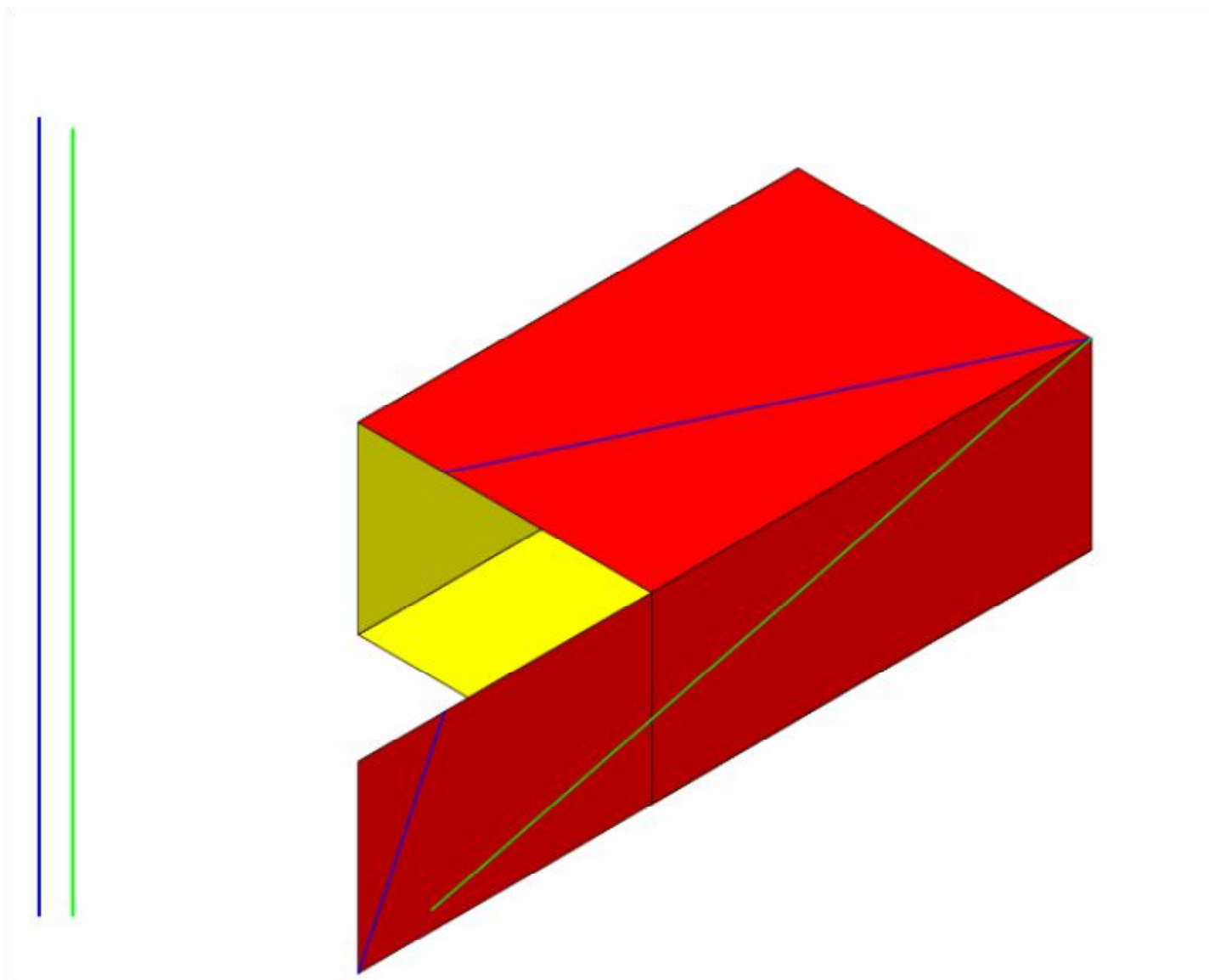

# La fourmi sur la caisse

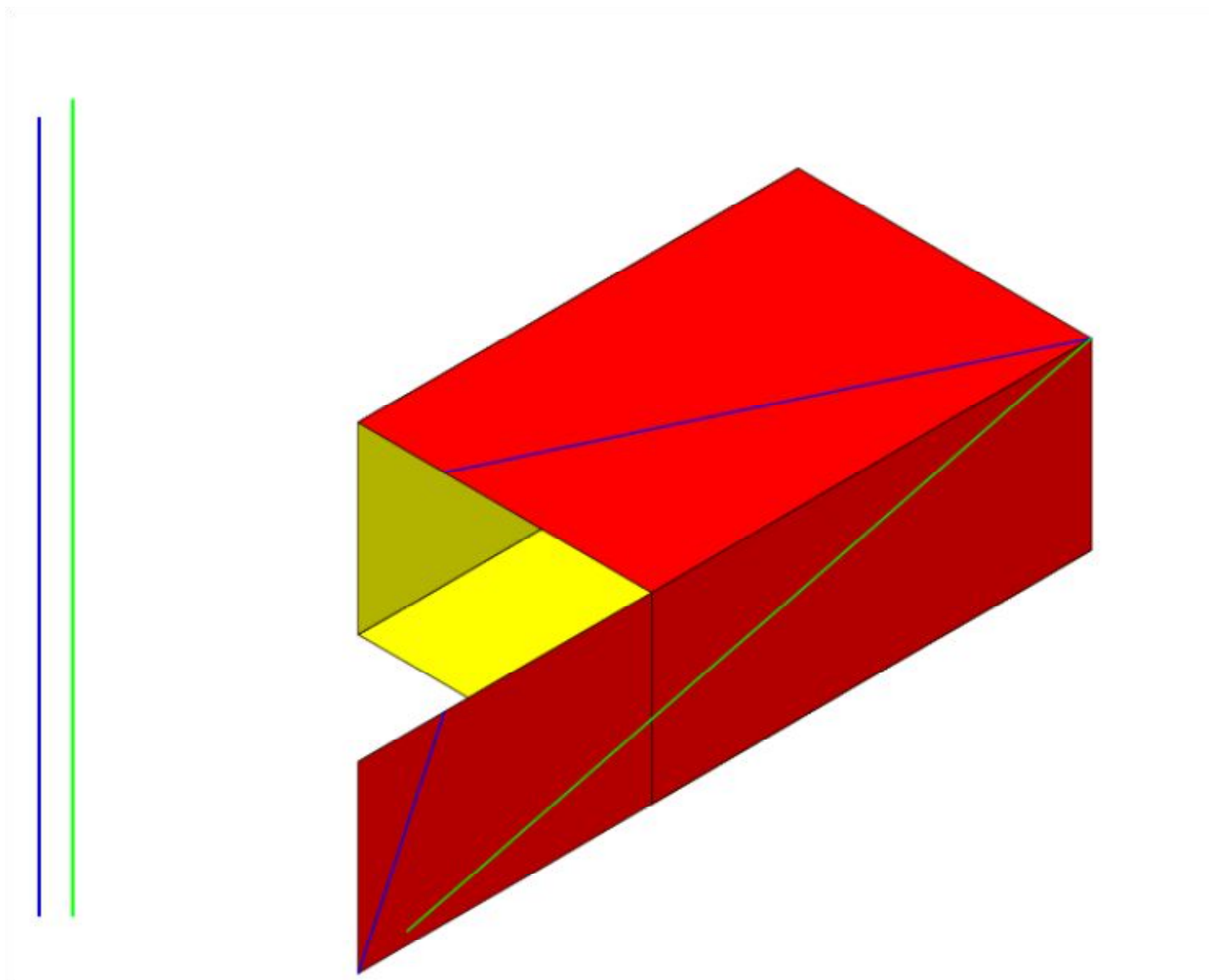

# La fourmi sur la caisse

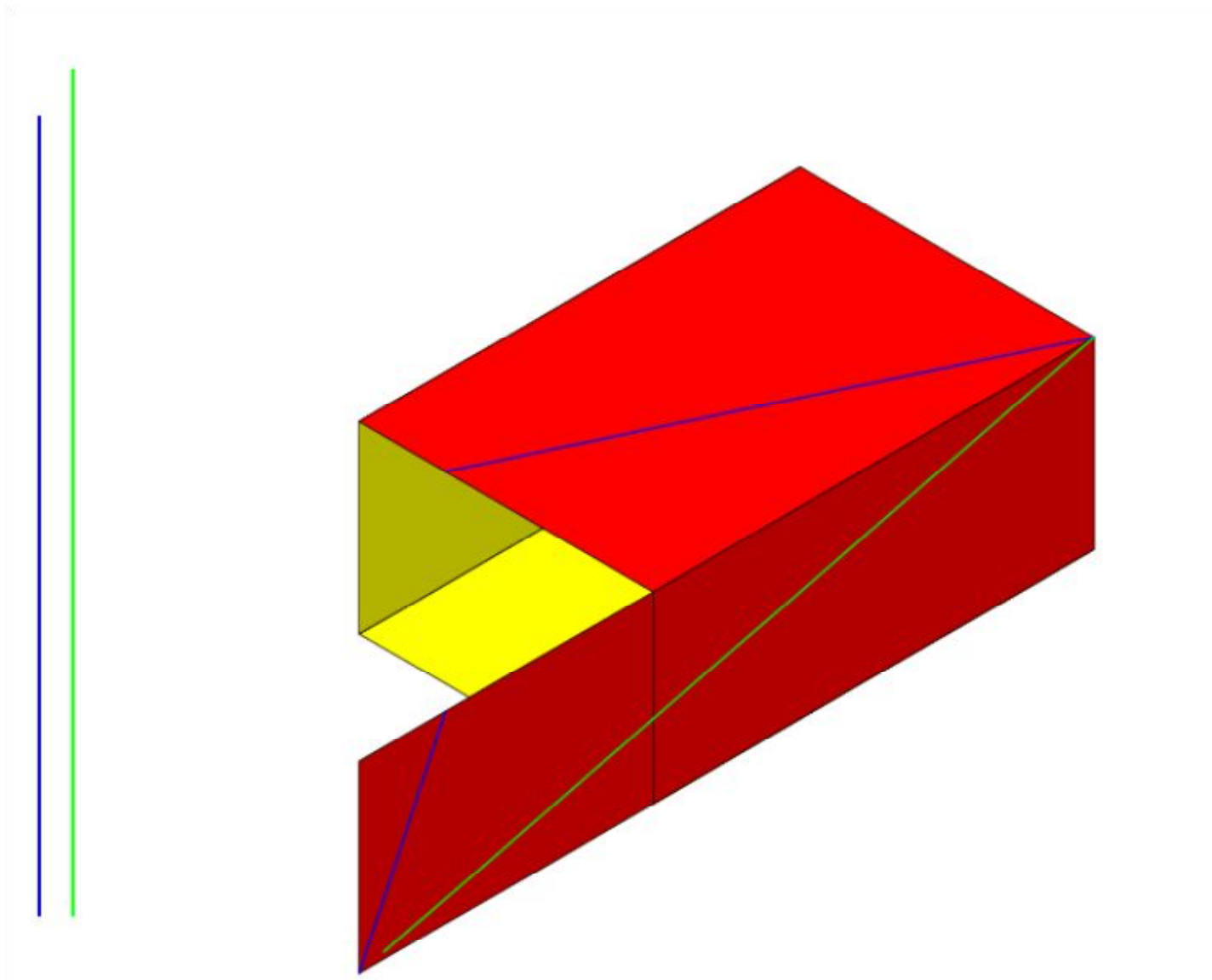

# La fourmi sur la caisse

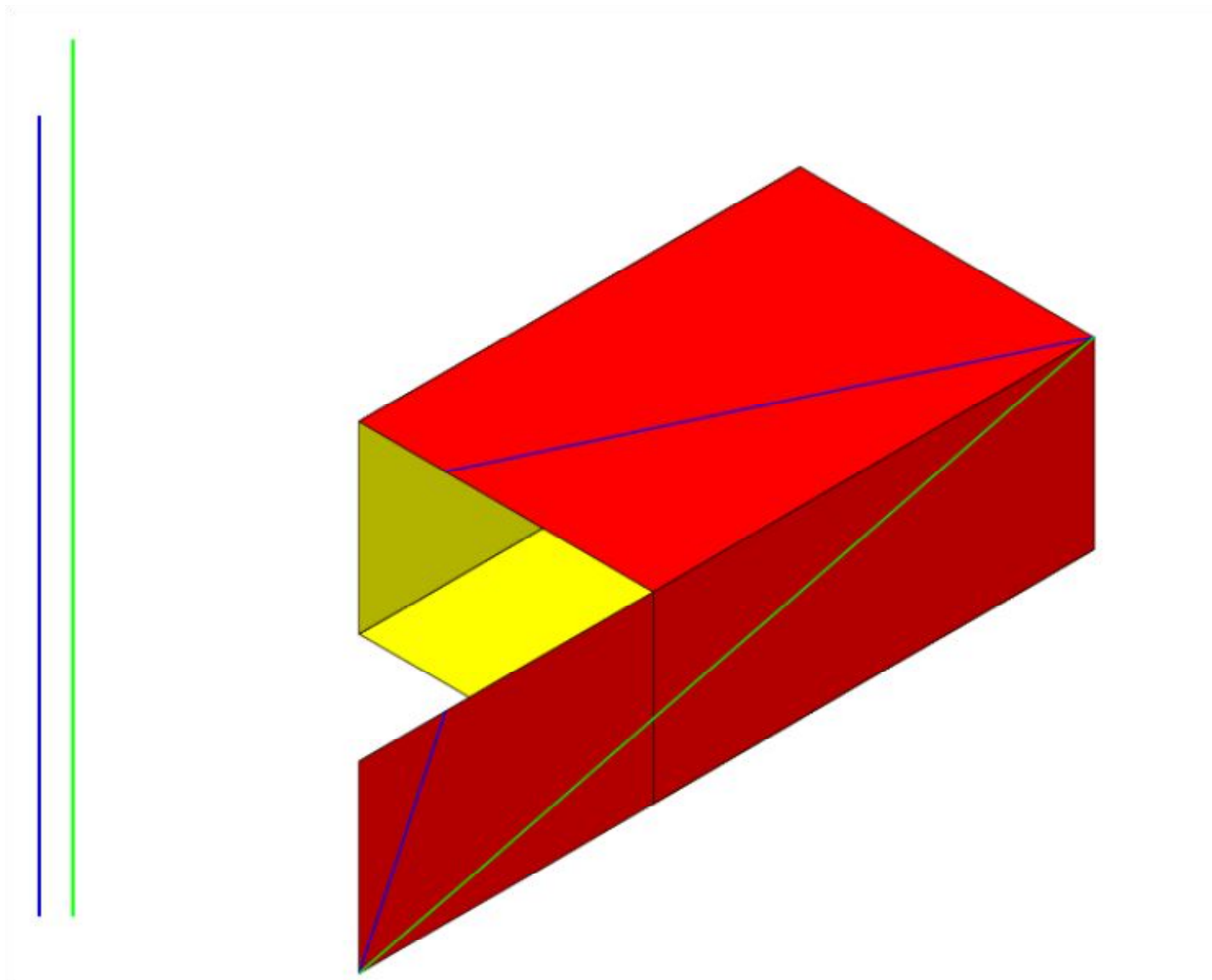

# La fourmi sur la caisse

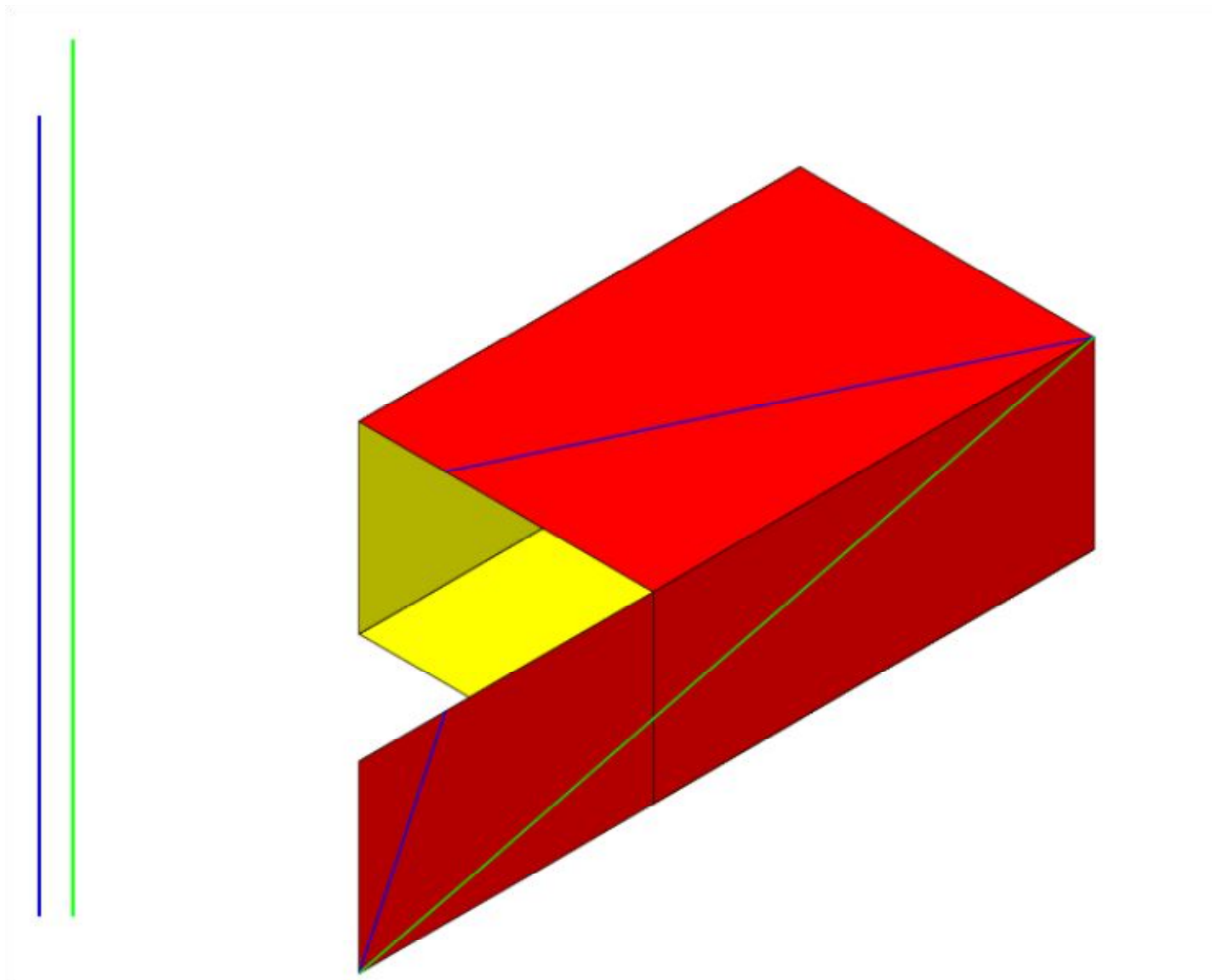



# La fourmi sur la caisse

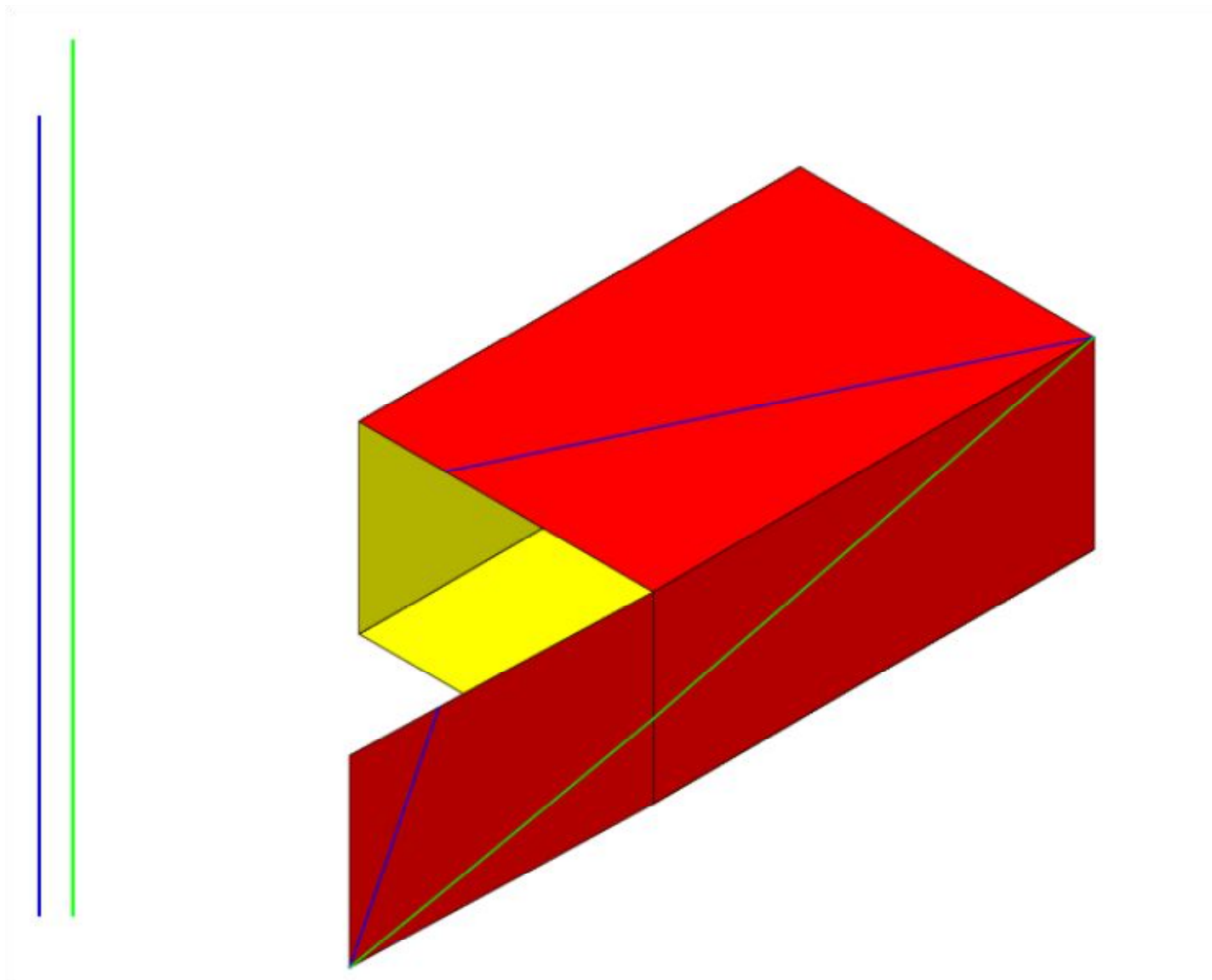

# La fourmi sur la caisse

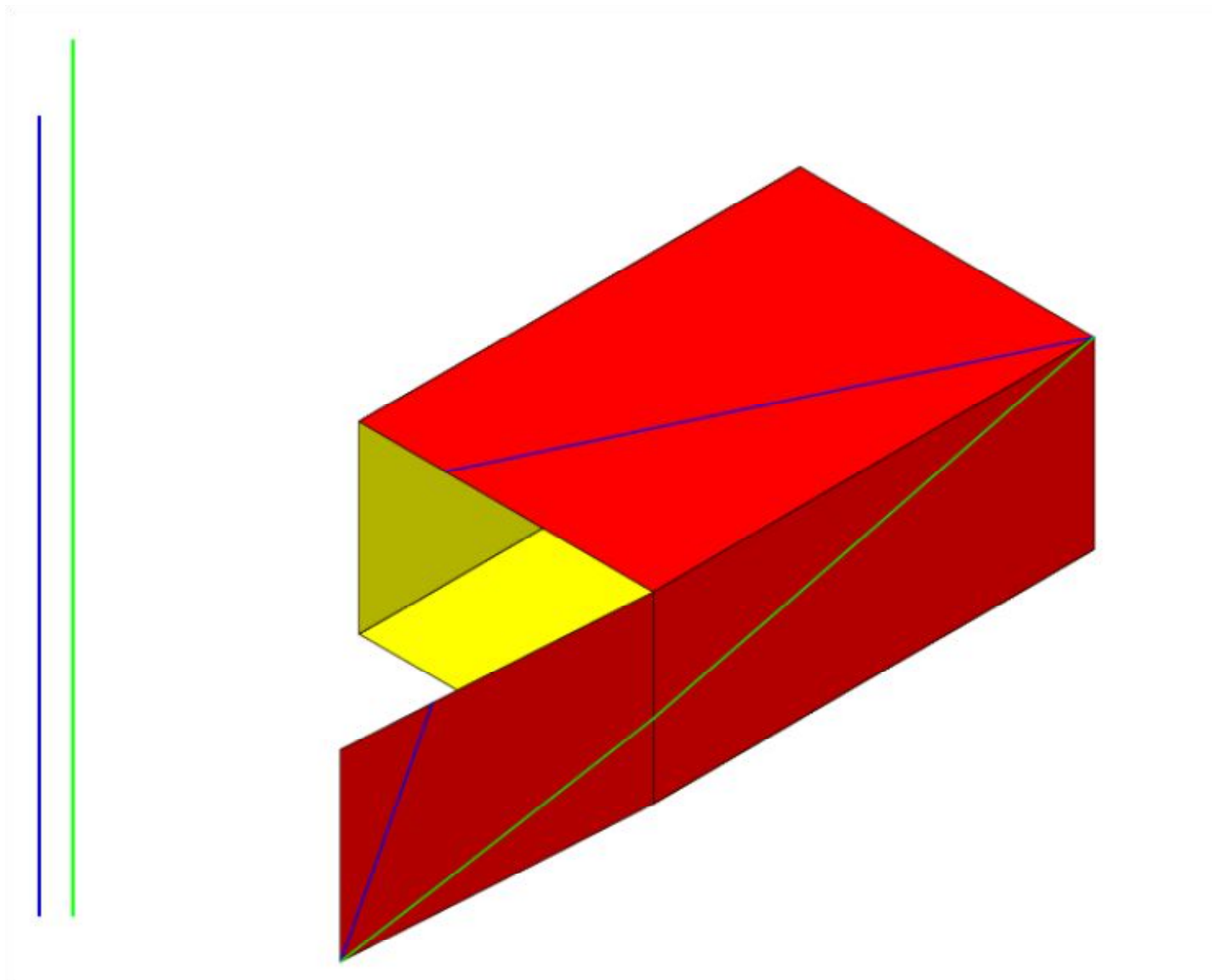

# La fourmi sur la caisse

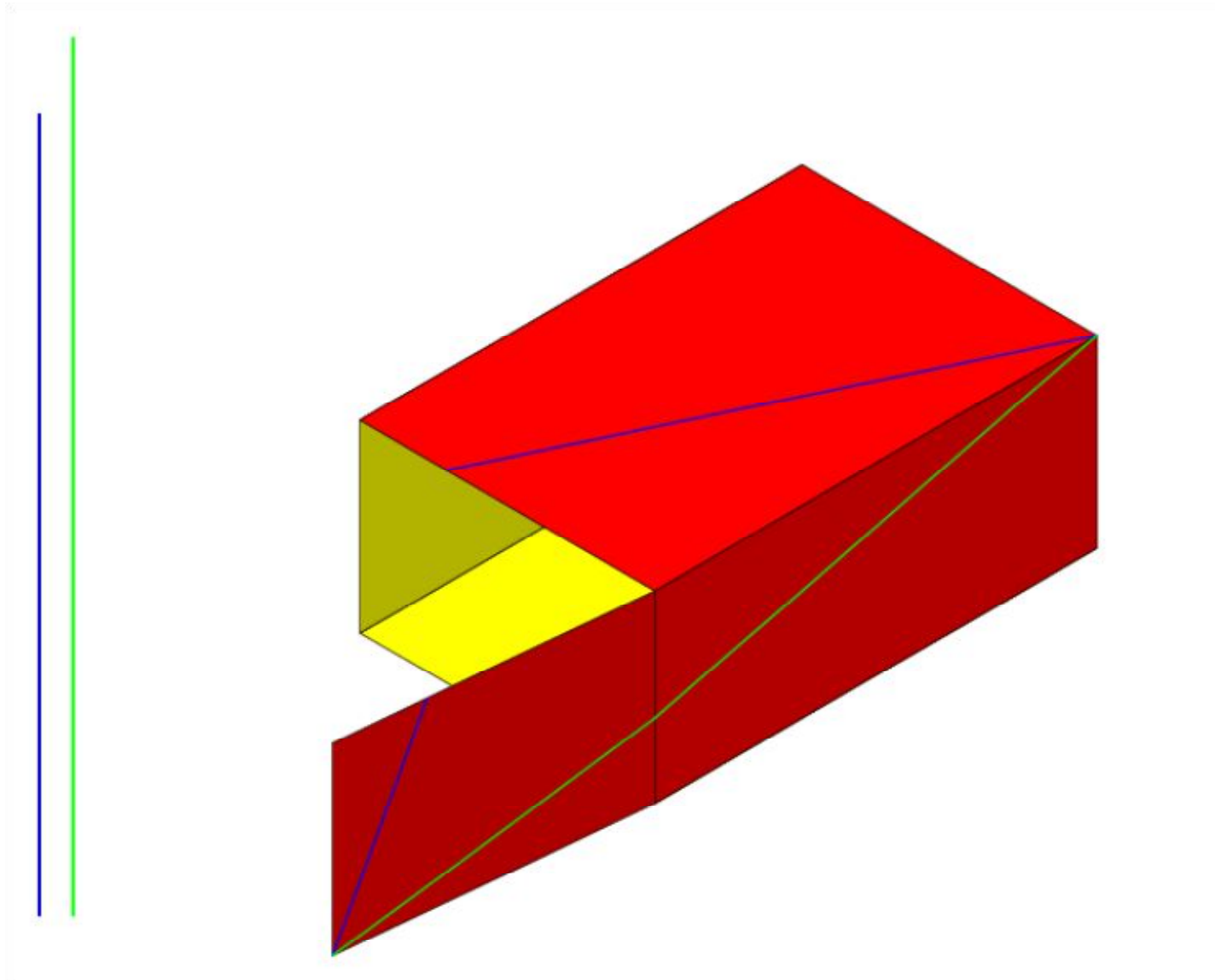

# La fourmi sur la caisse

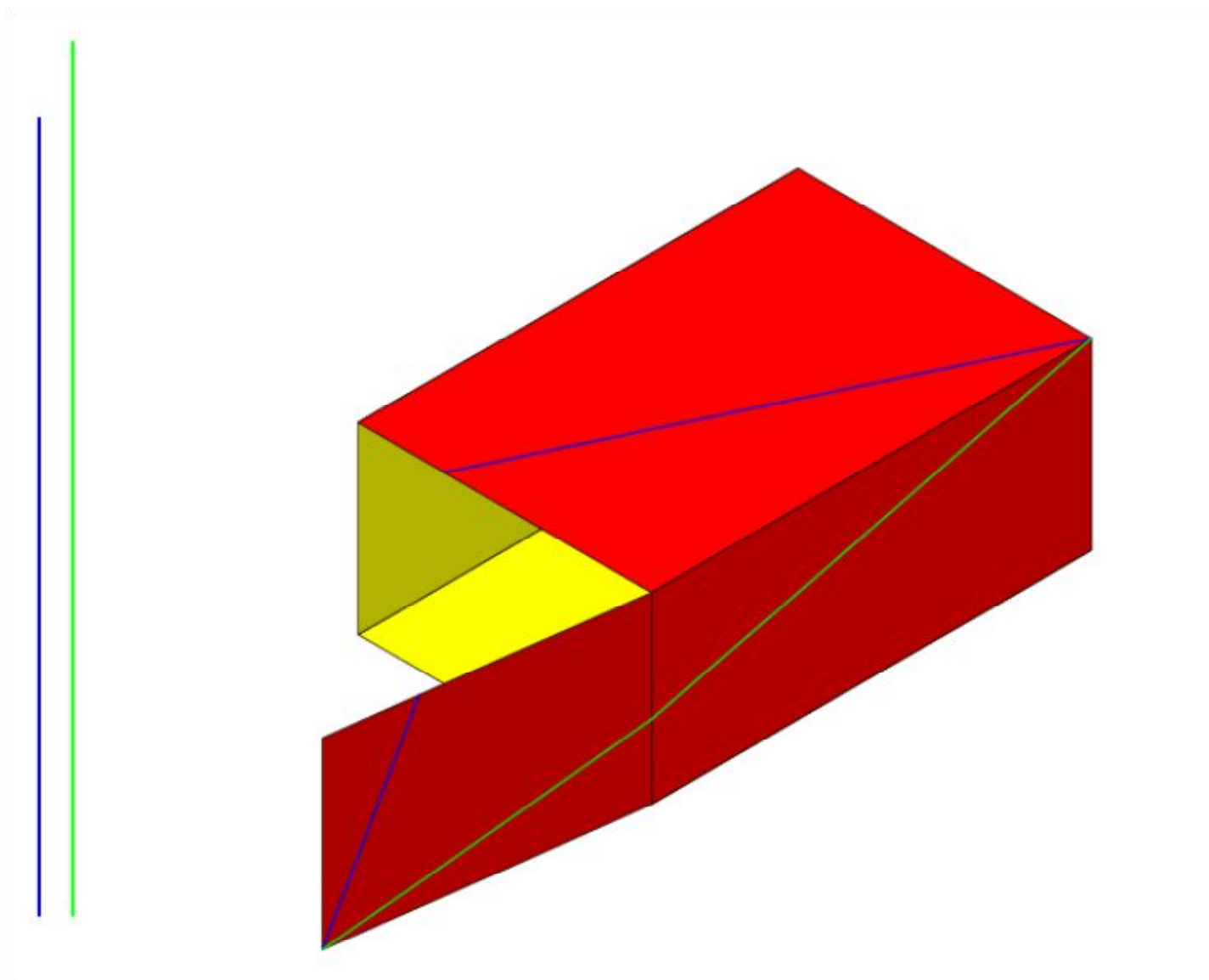

# La fourmi sur la caisse

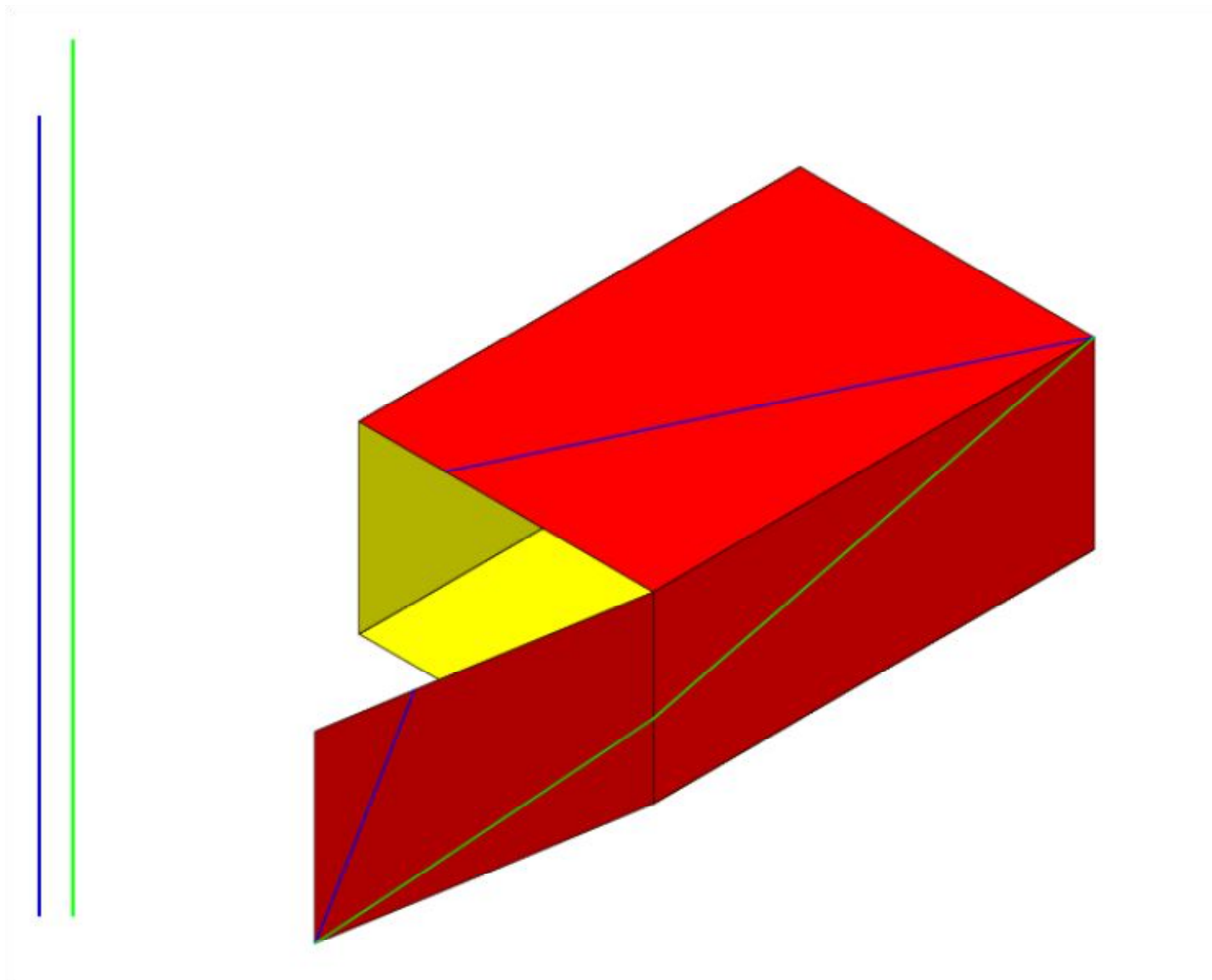

# La fourmi sur la caisse

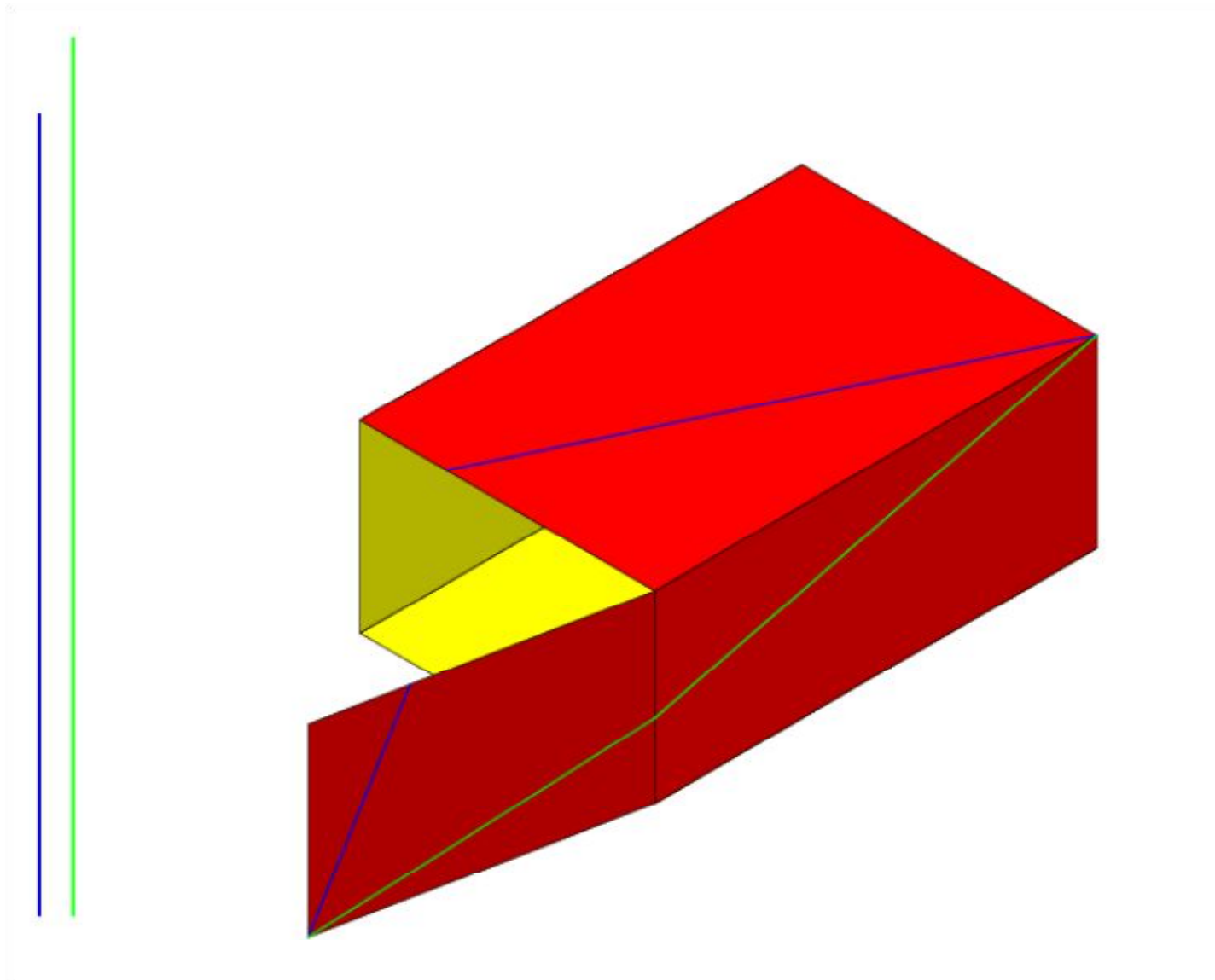

# La fourmi sur la caisse

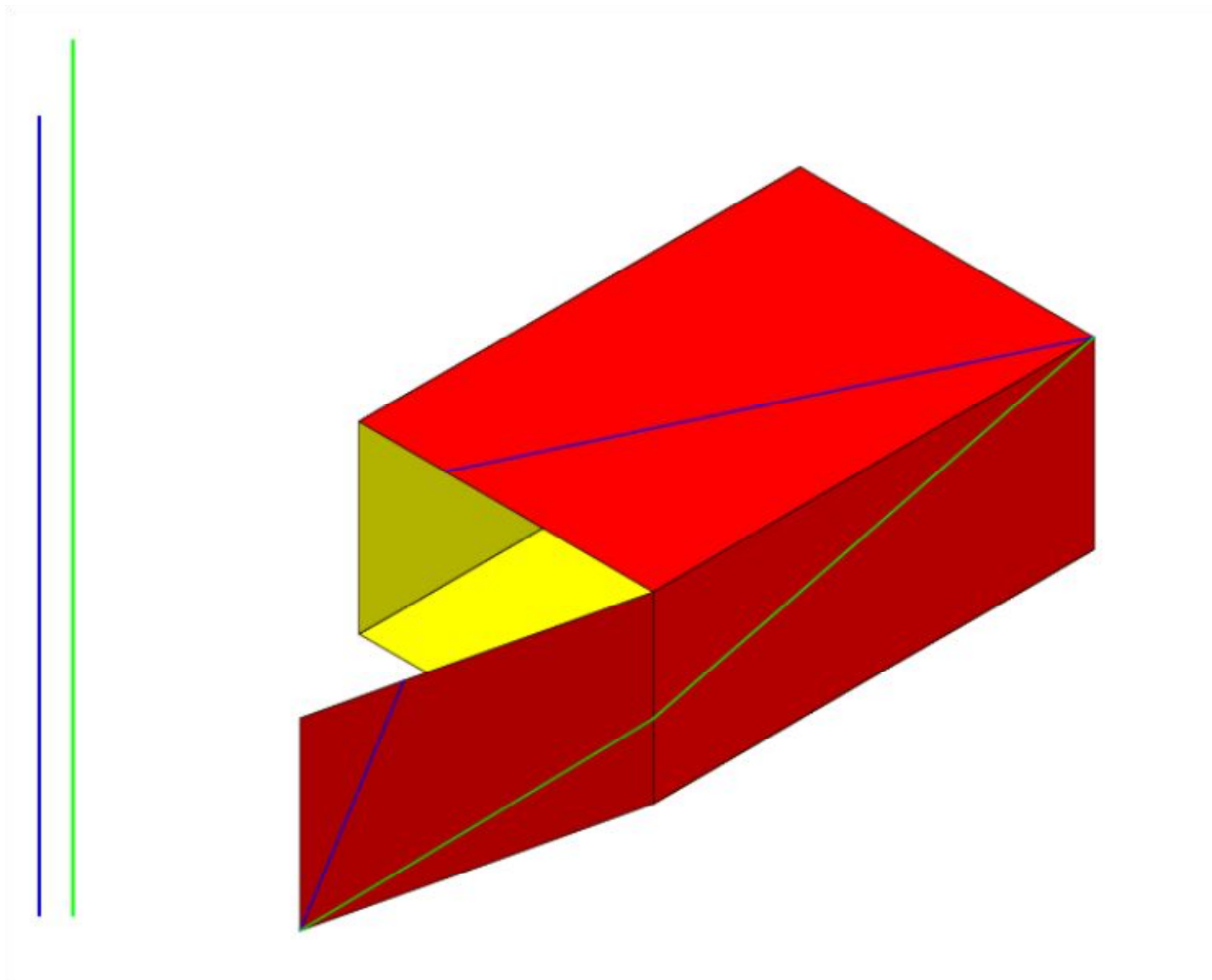

# La fourmi sur la caisse

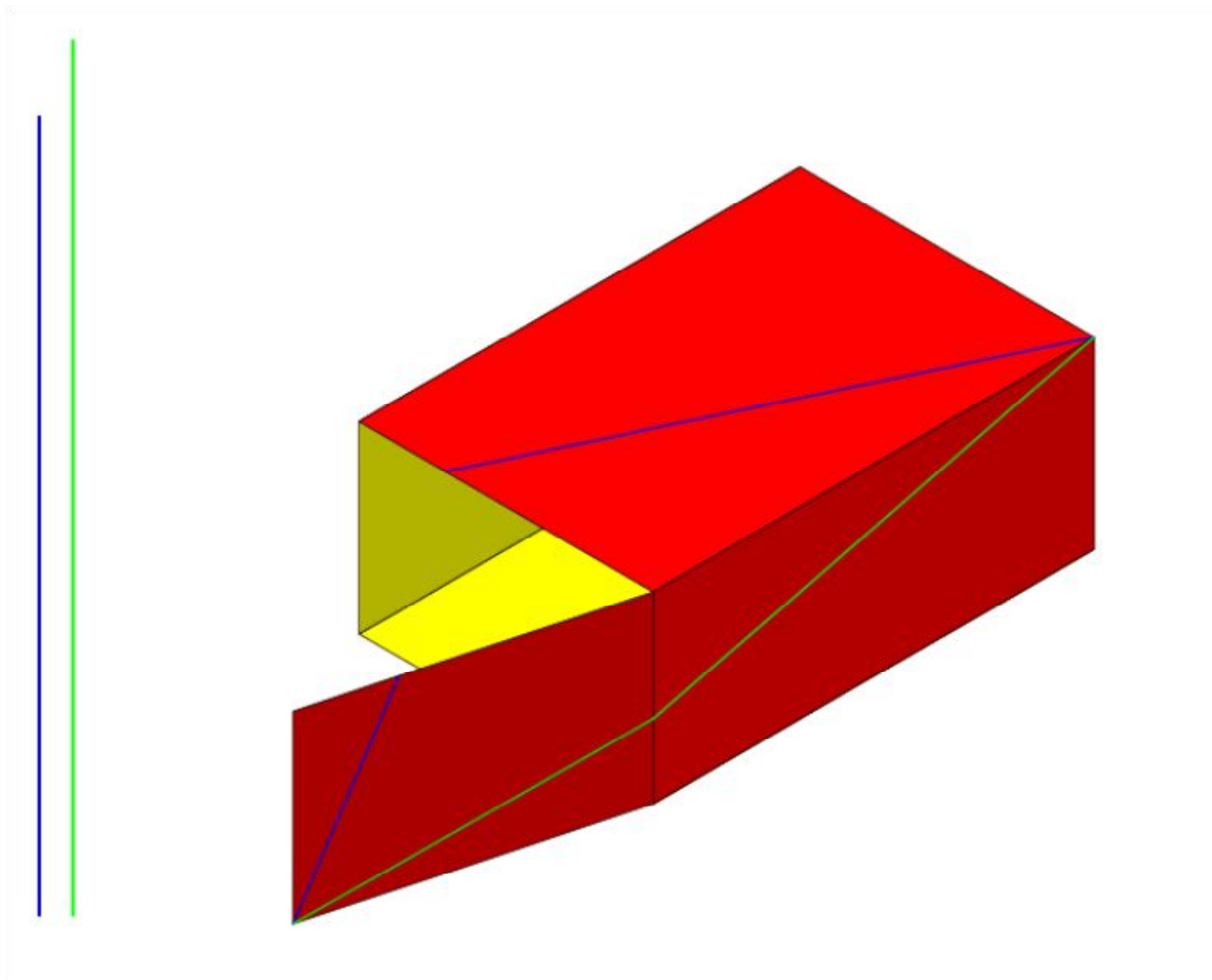



# La fourmi sur la caisse

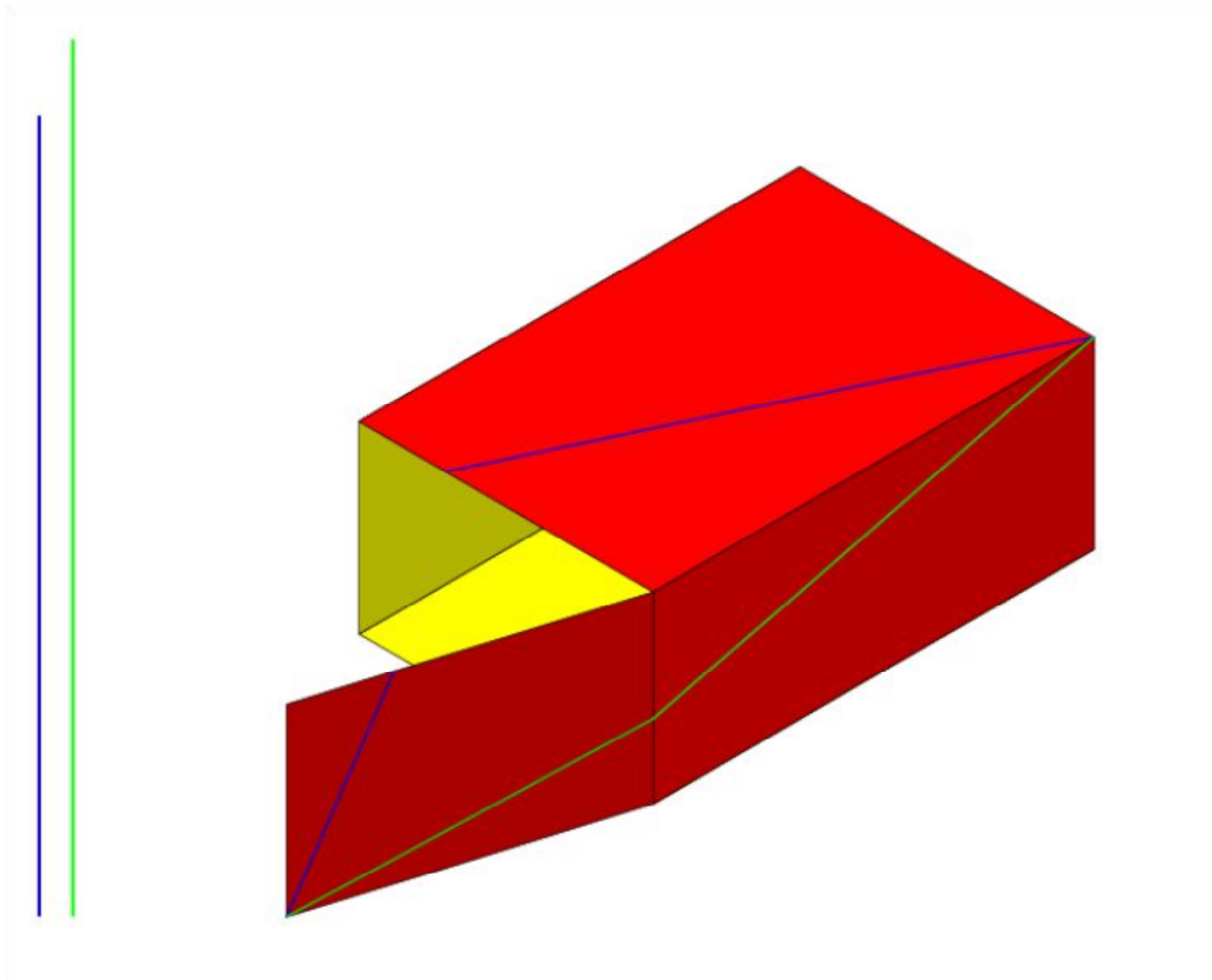

# La fourmi sur la caisse

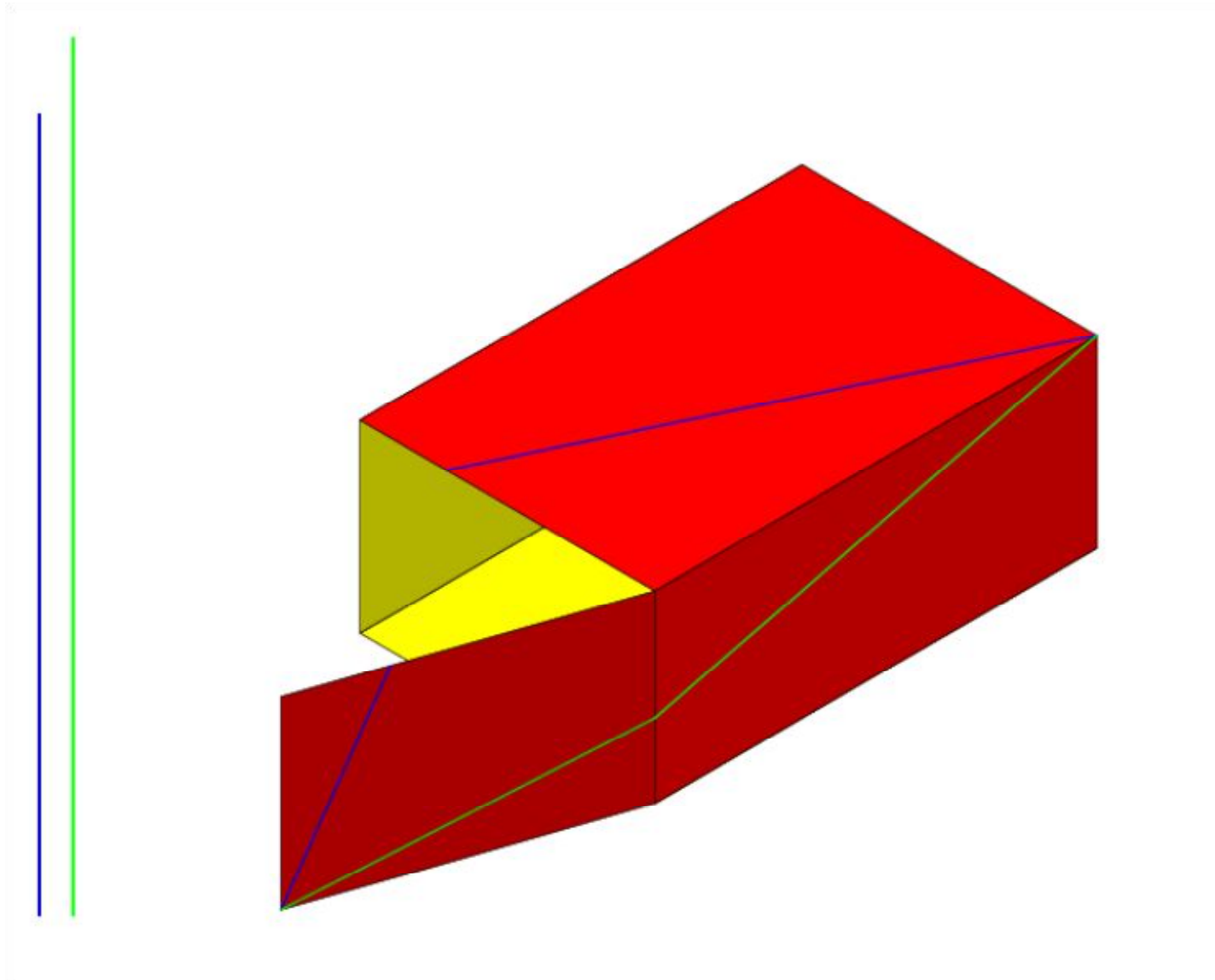

# La fourmi sur la caisse

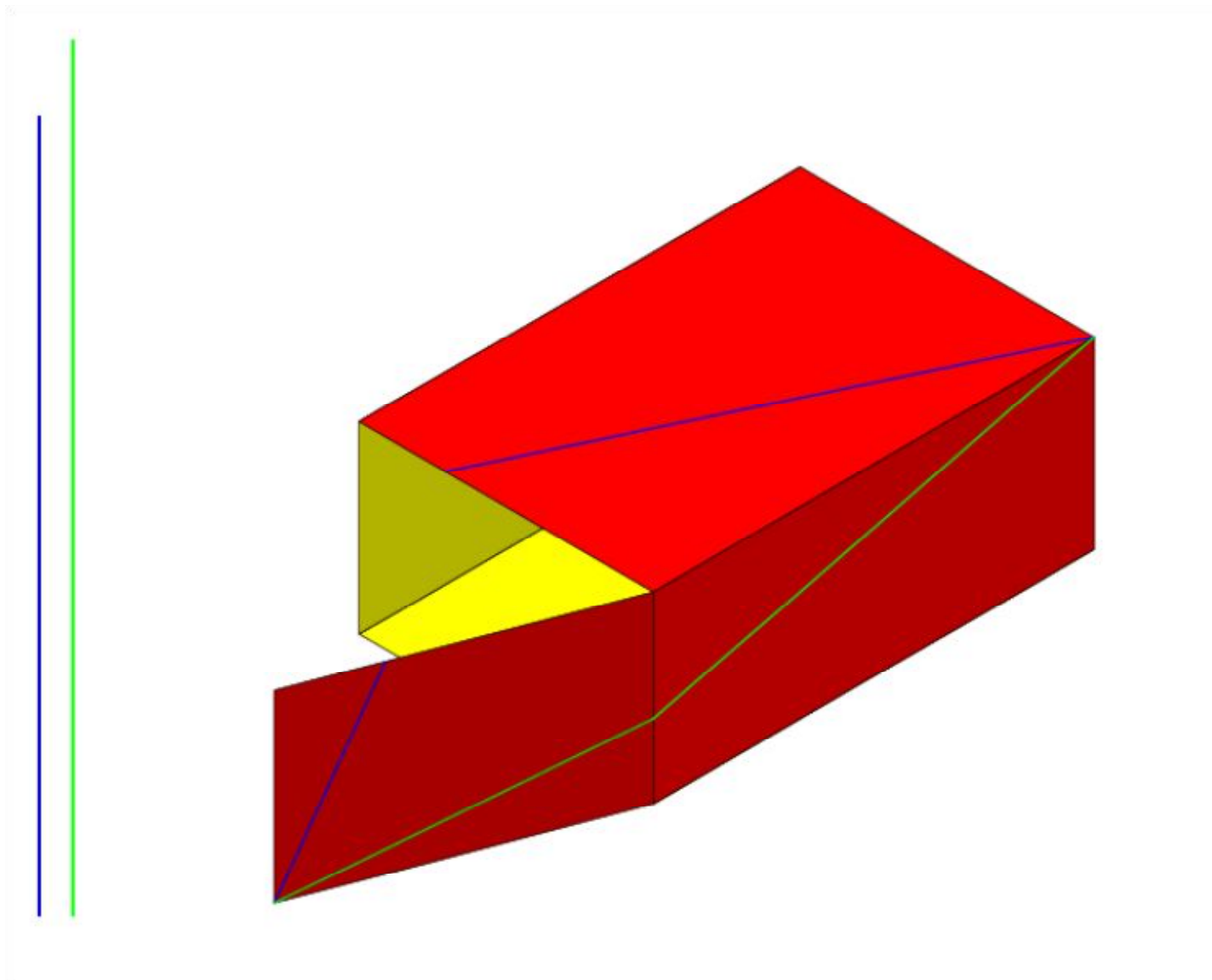

# La fourmi sur la caisse

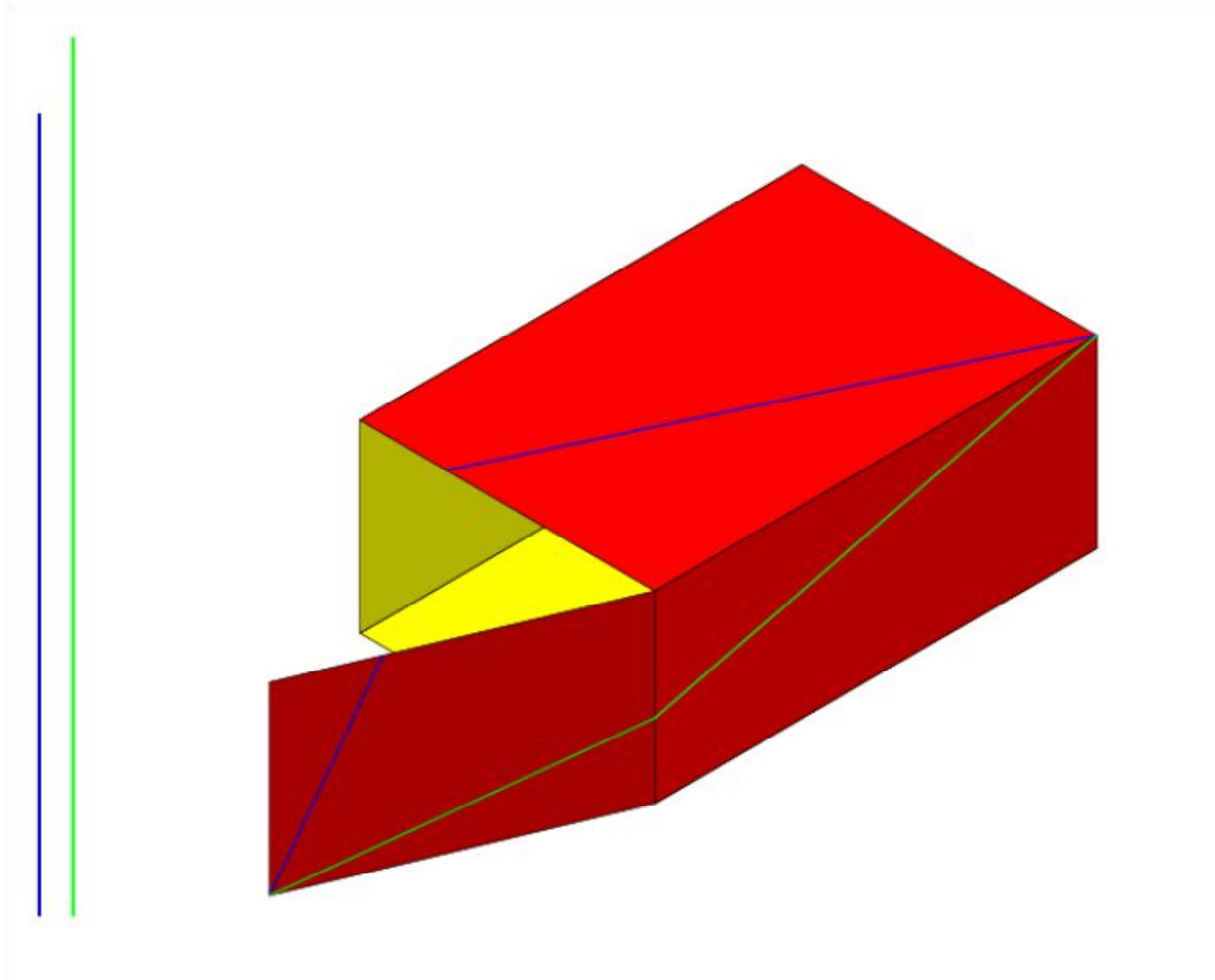

# La fourmi sur la caisse

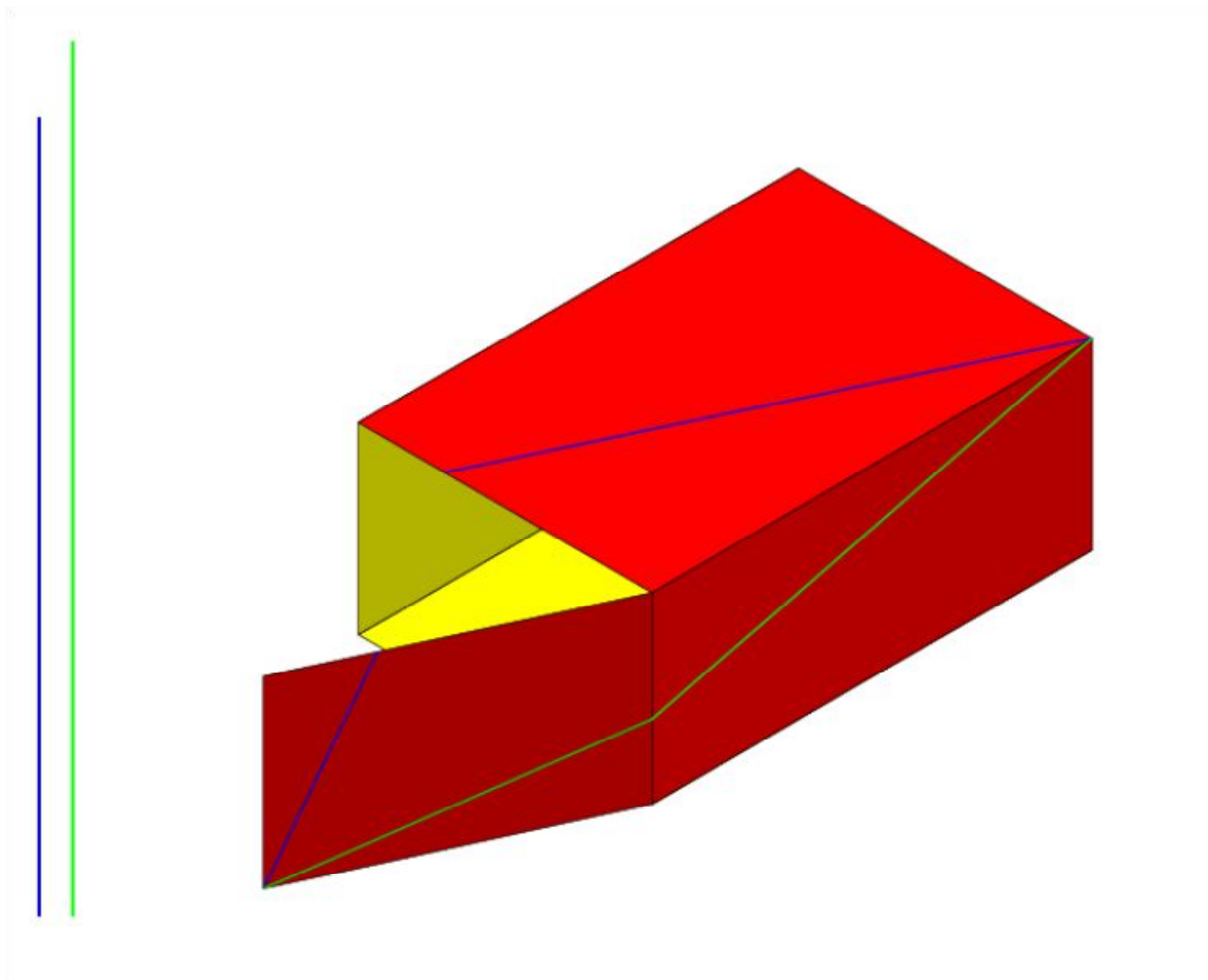

# La fourmi sur la caisse

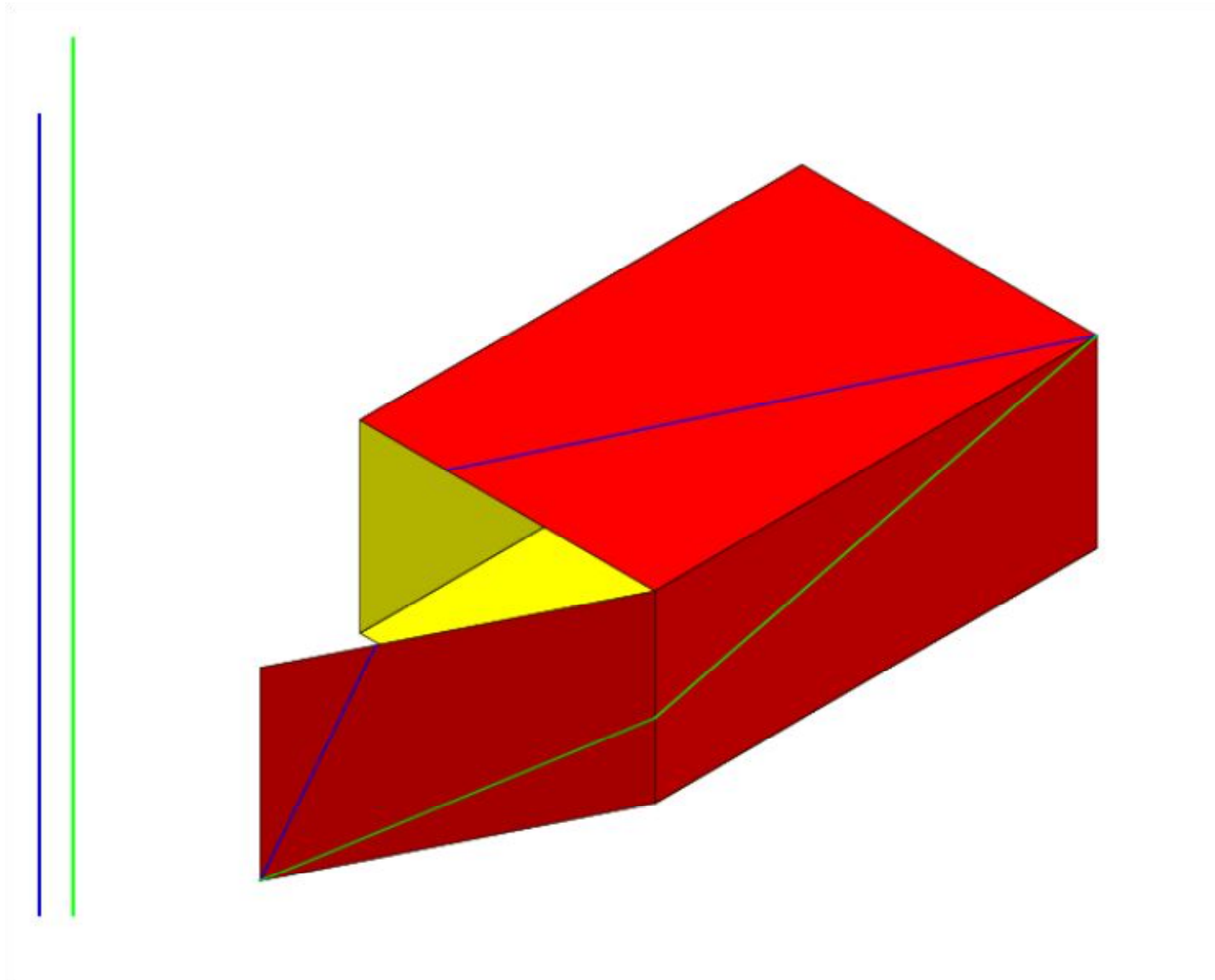

# La fourmi sur la caisse

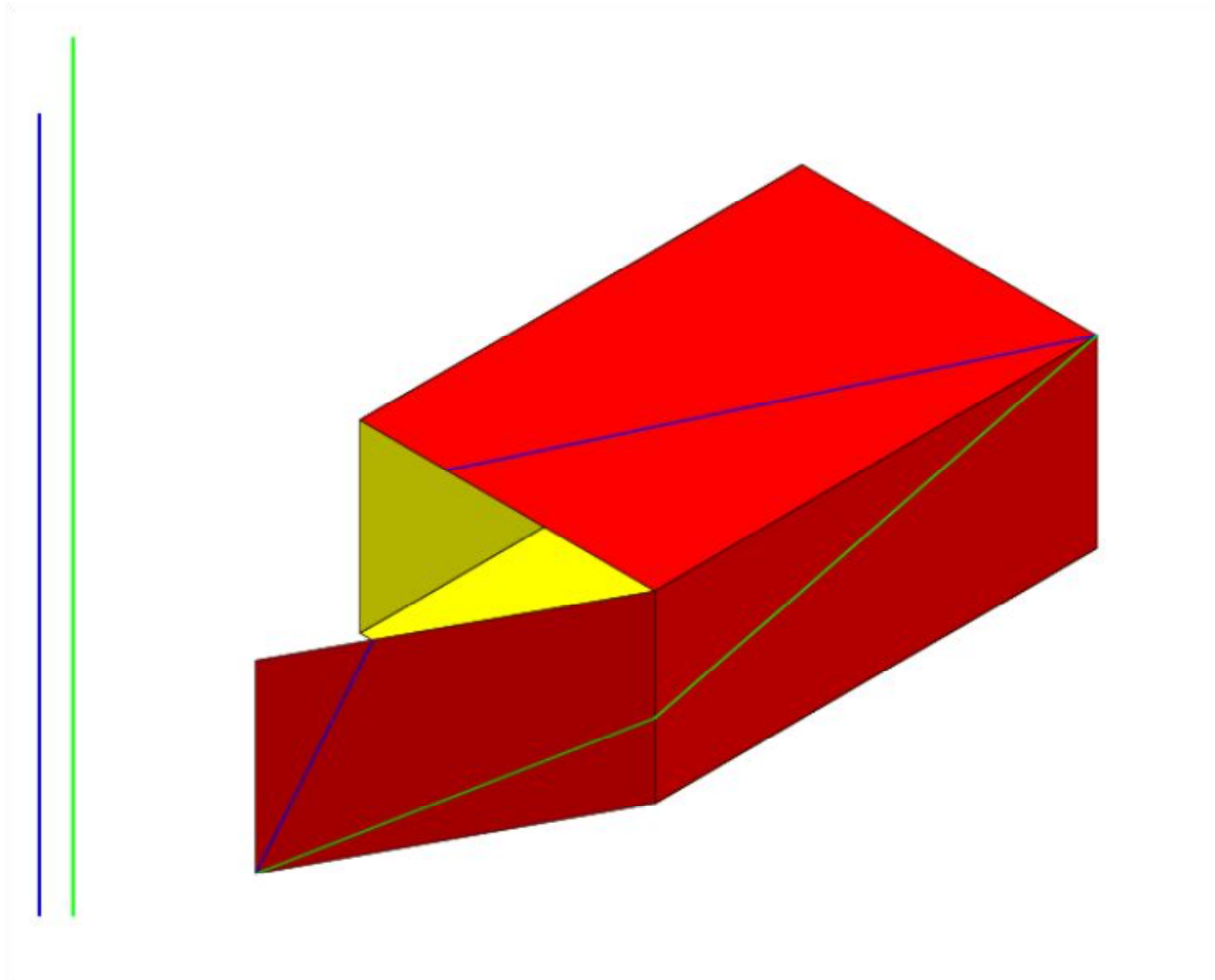

# La fourmi sur la caisse

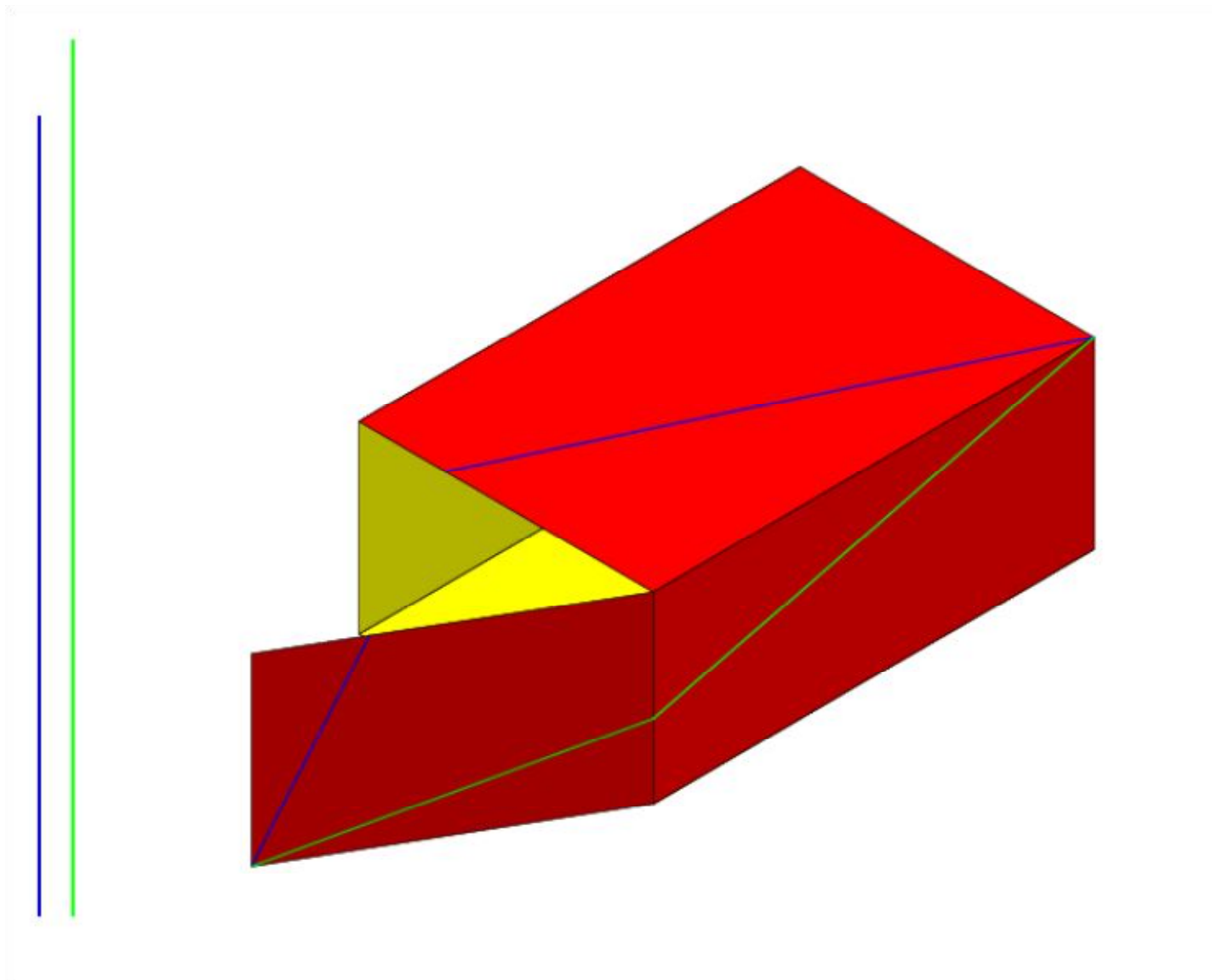



# La fourmi sur la caisse

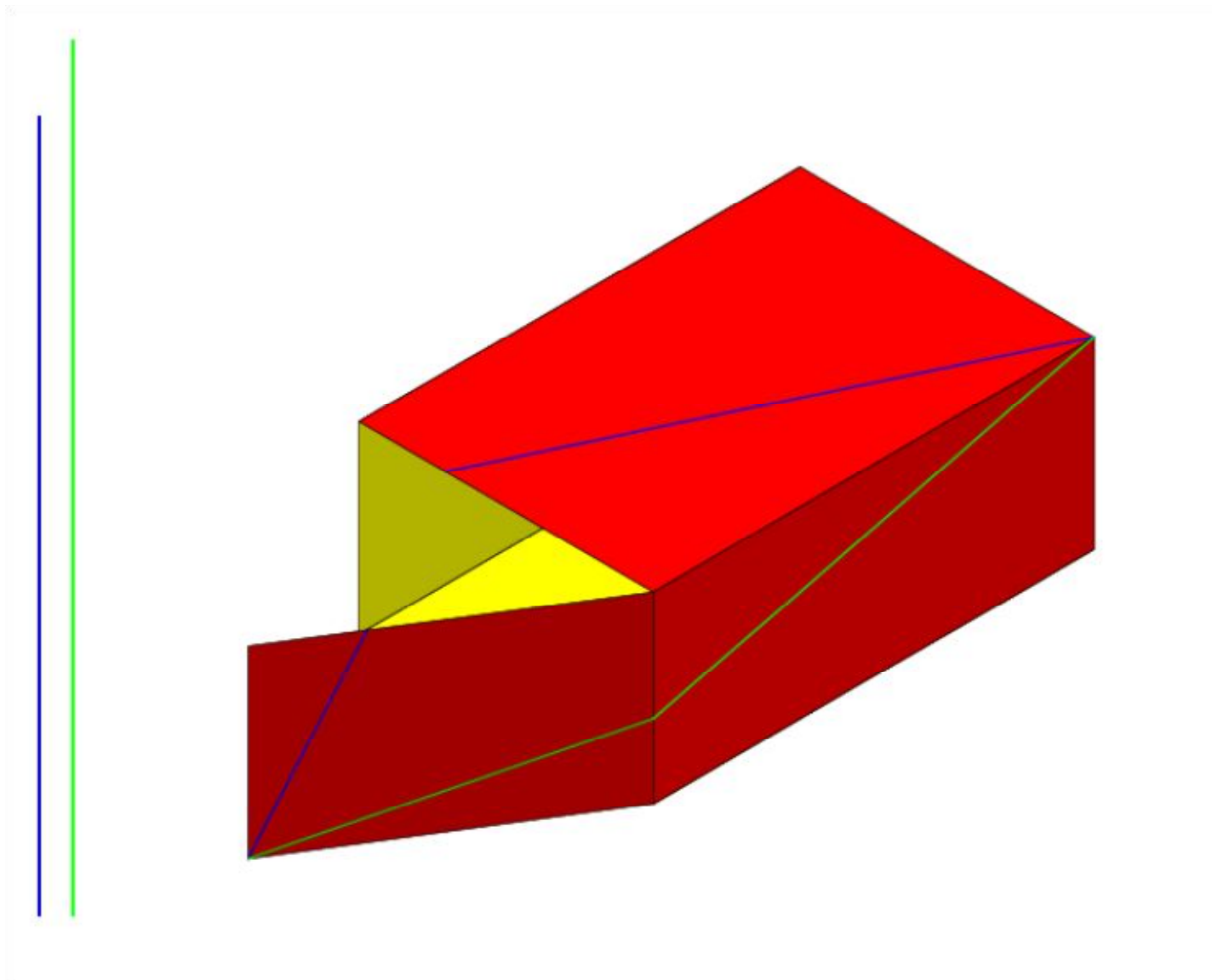

# La fourmi sur la caisse

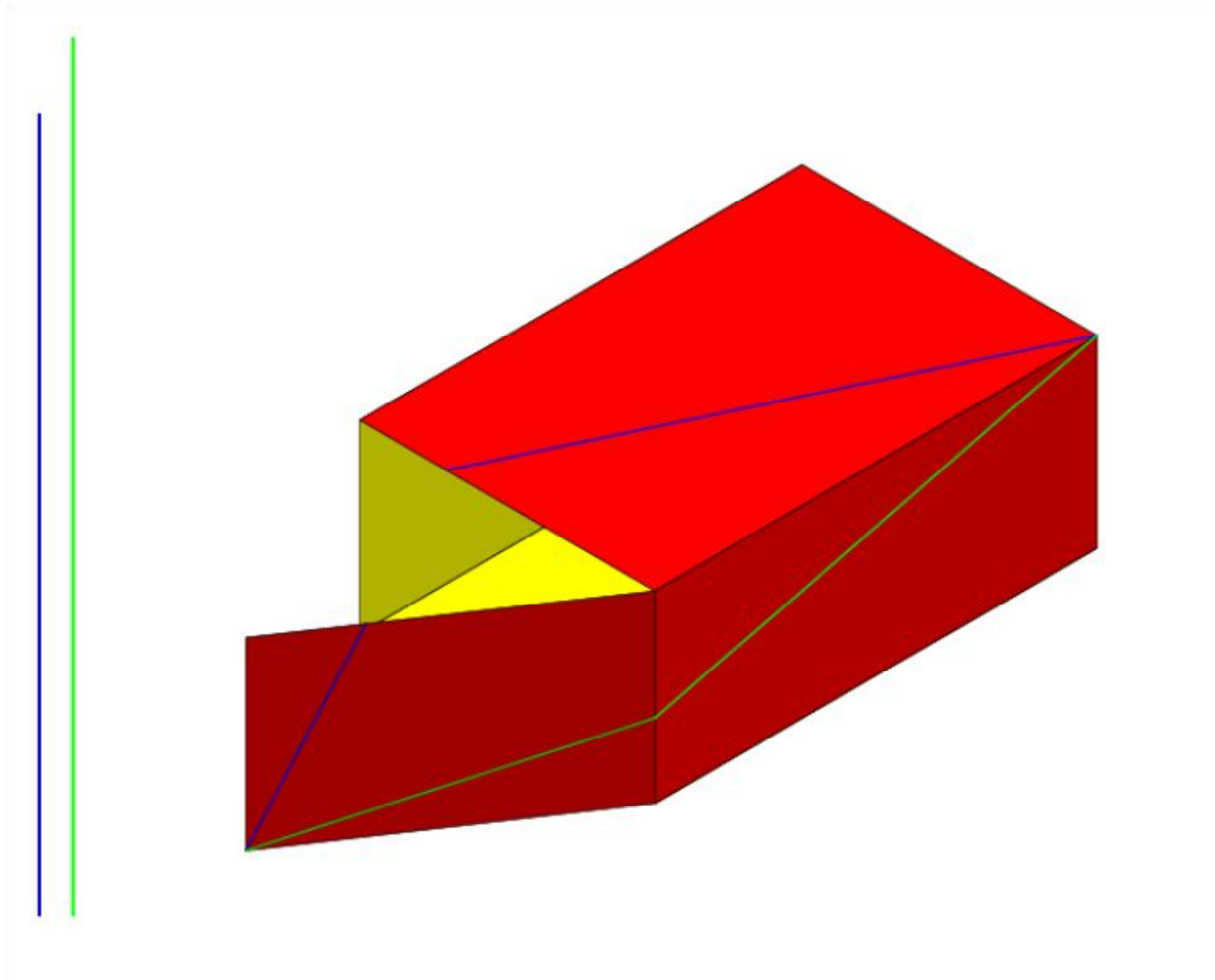

# La fourmi sur la caisse

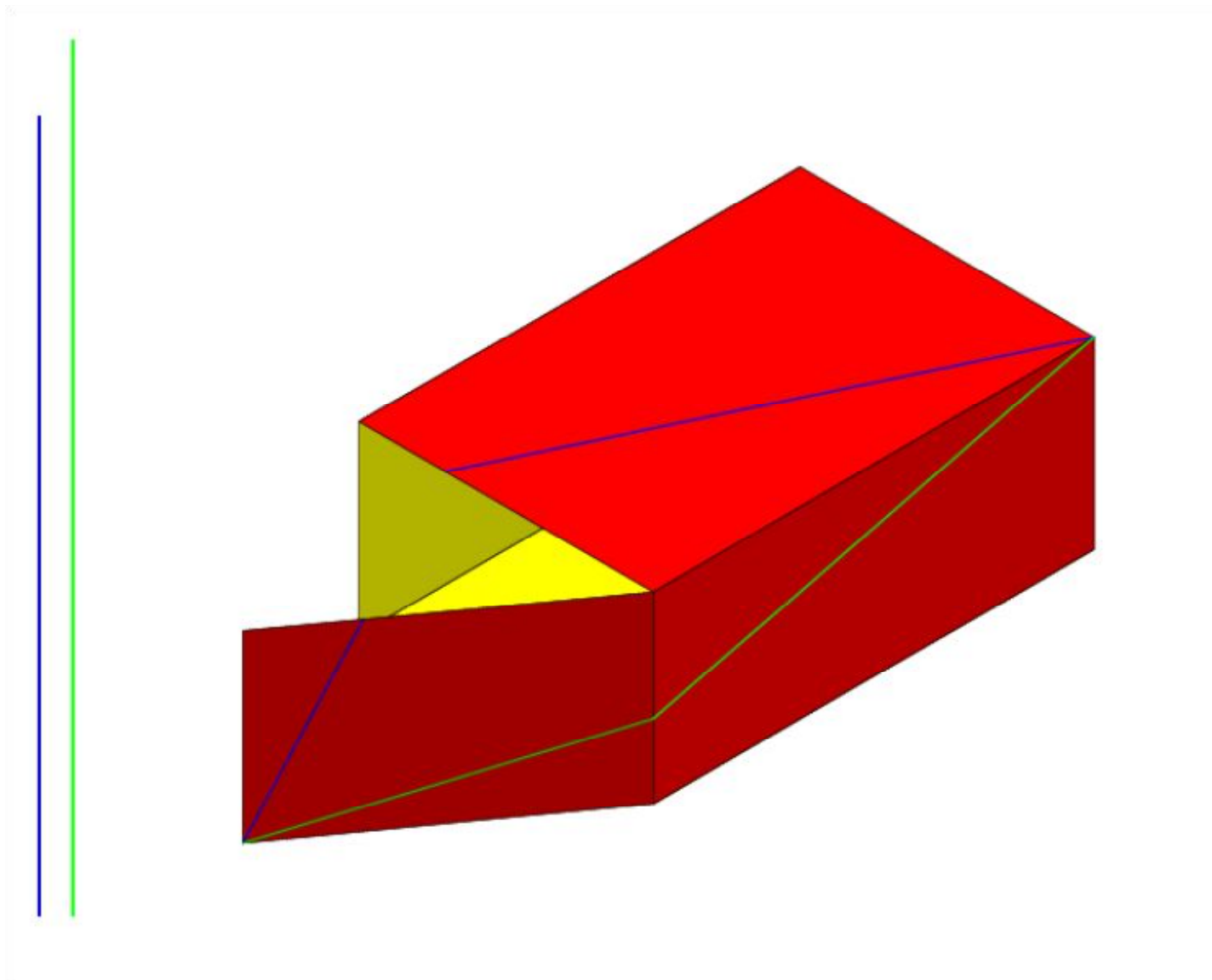

# La fourmi sur la caisse

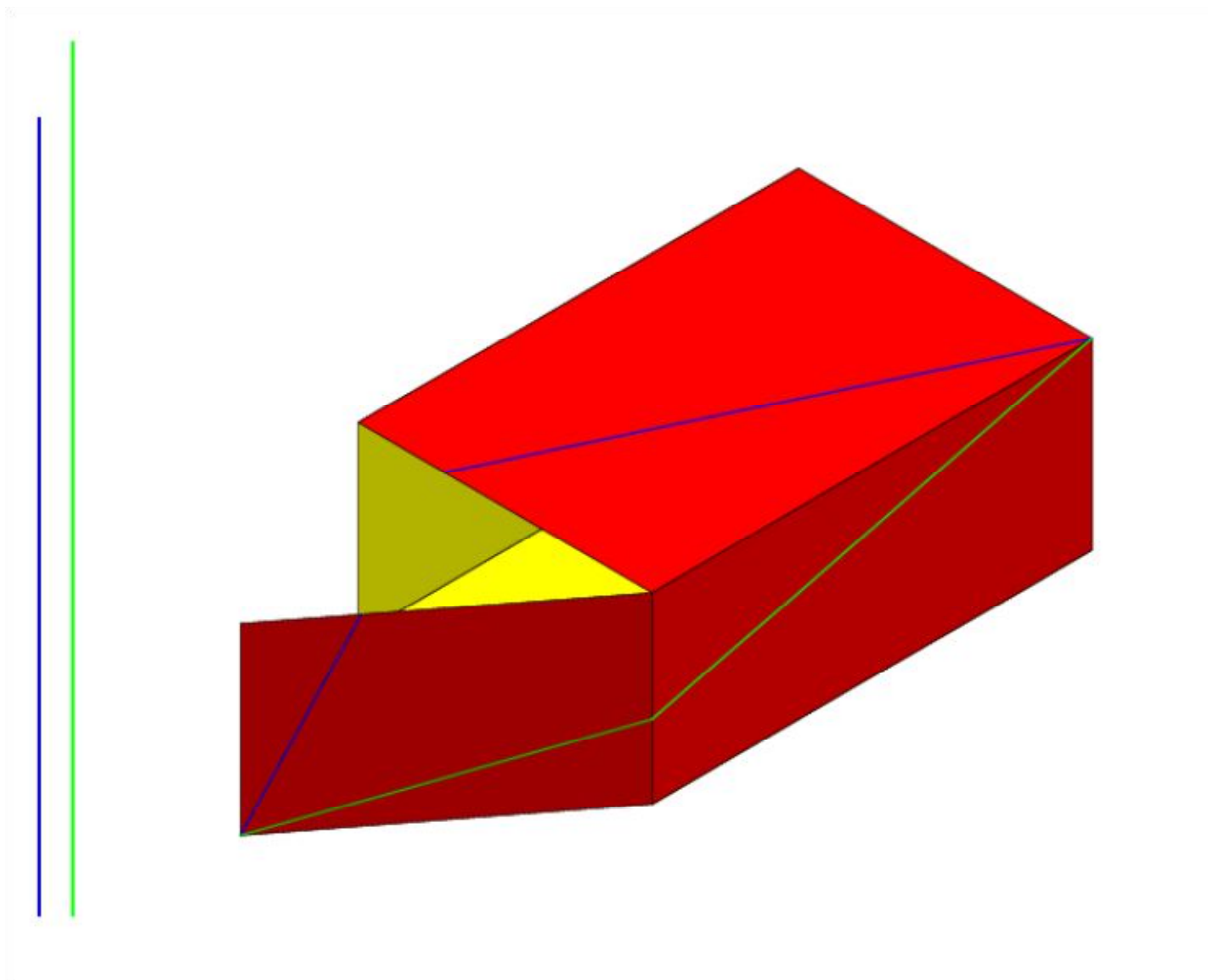

# La fourmi sur la caisse

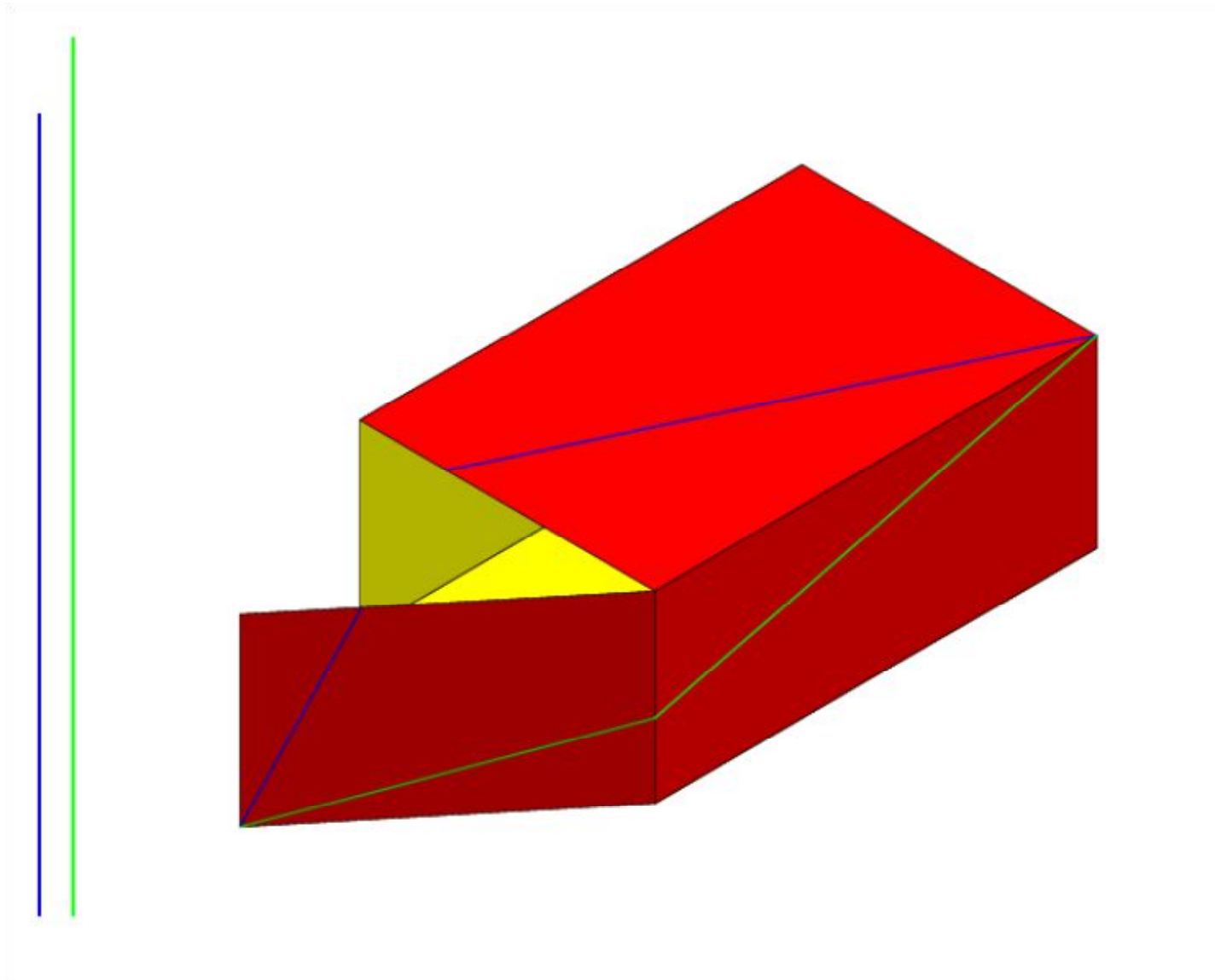

# La fourmi sur la caisse

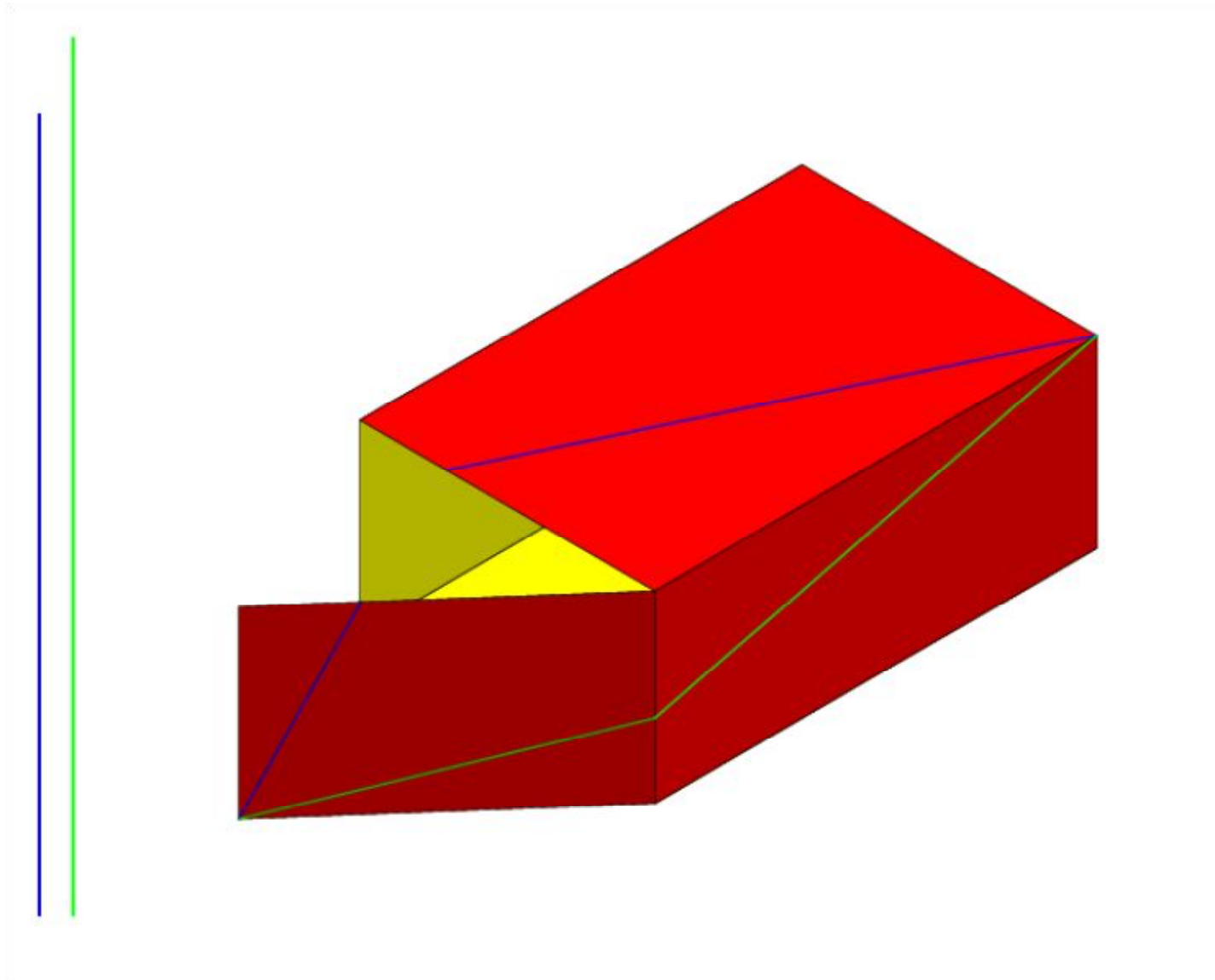

# La fourmi sur la caisse

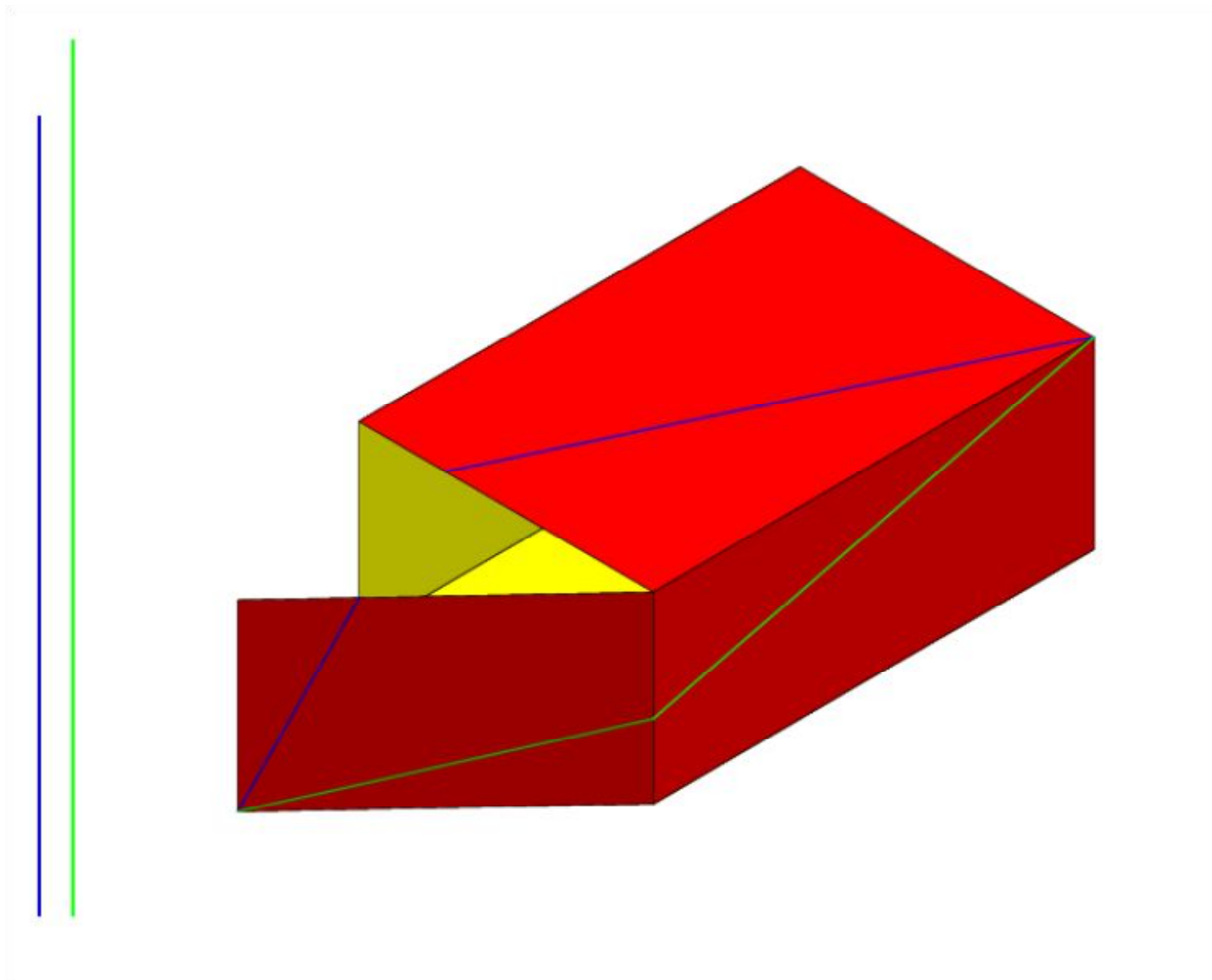

# La fourmi sur la caisse

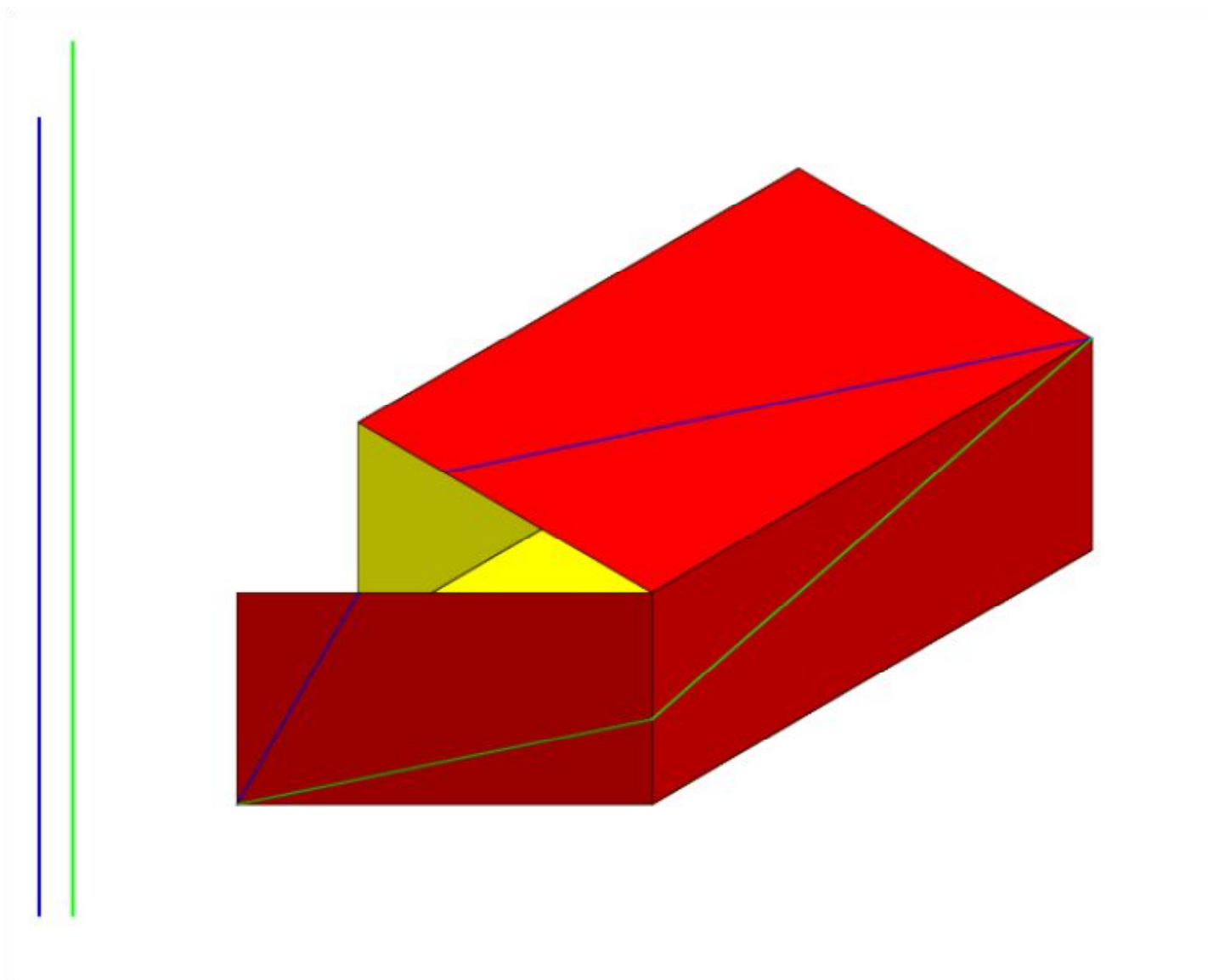



# La fourmi sur la caisse

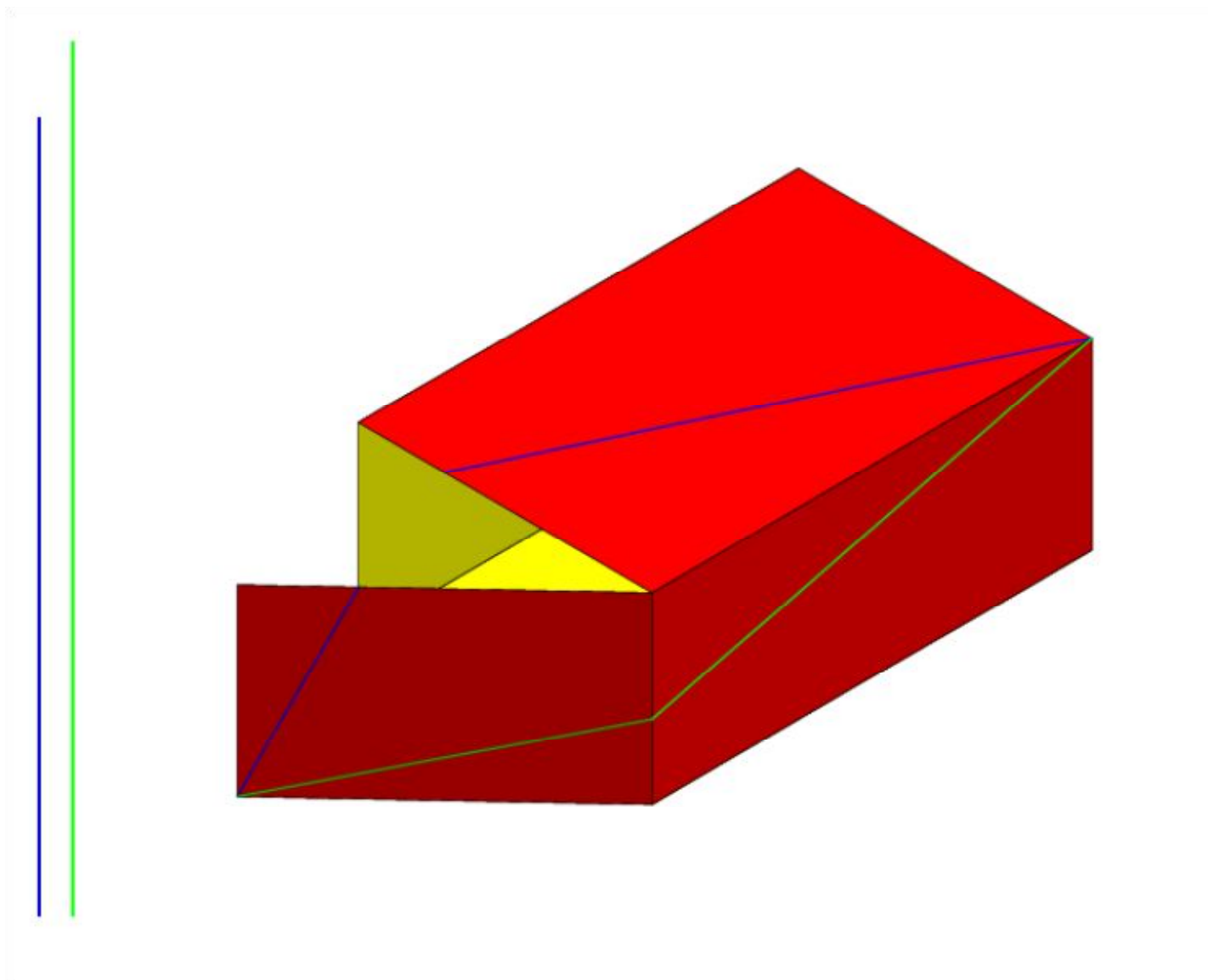

# La fourmi sur la caisse

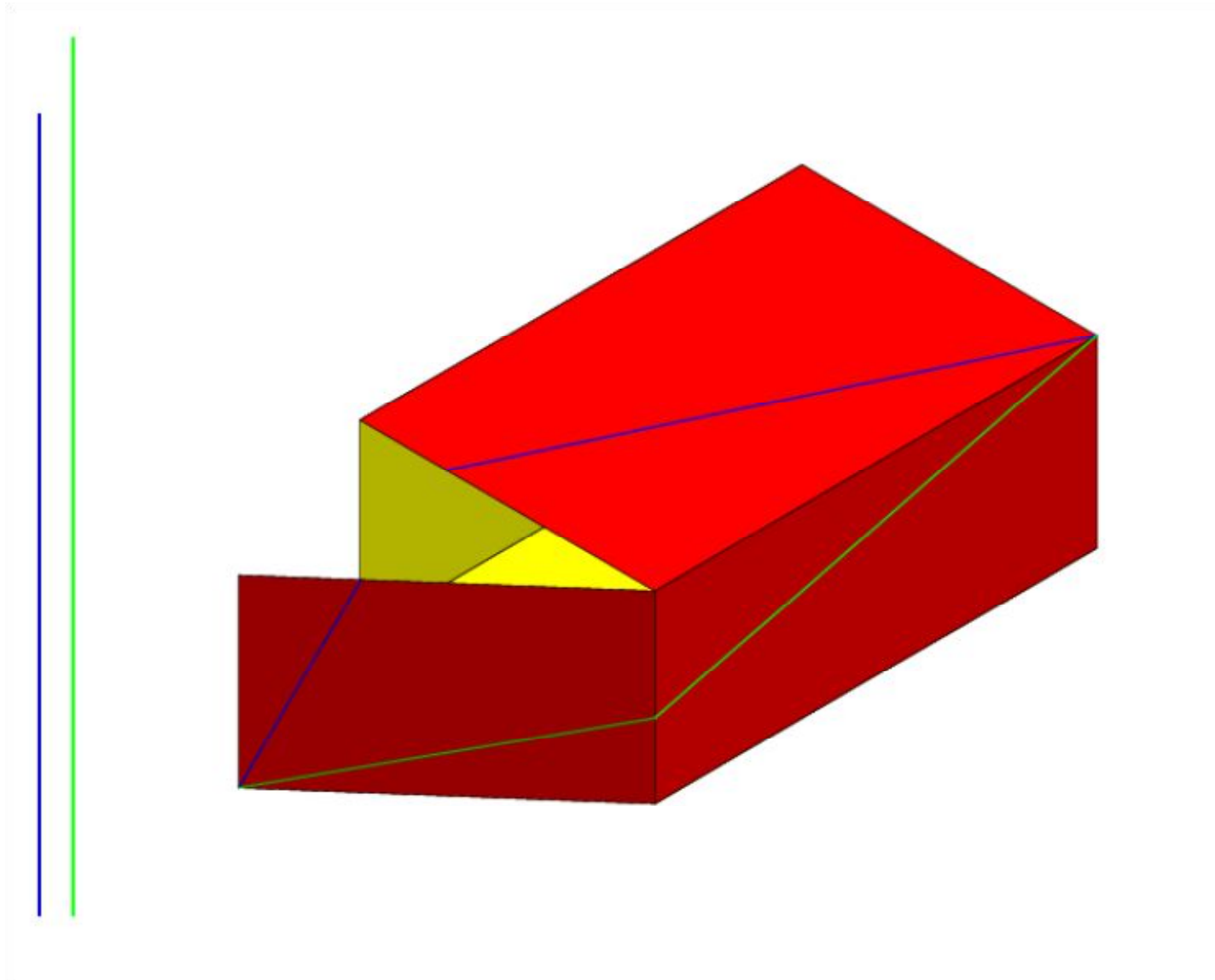

# La fourmi sur la caisse

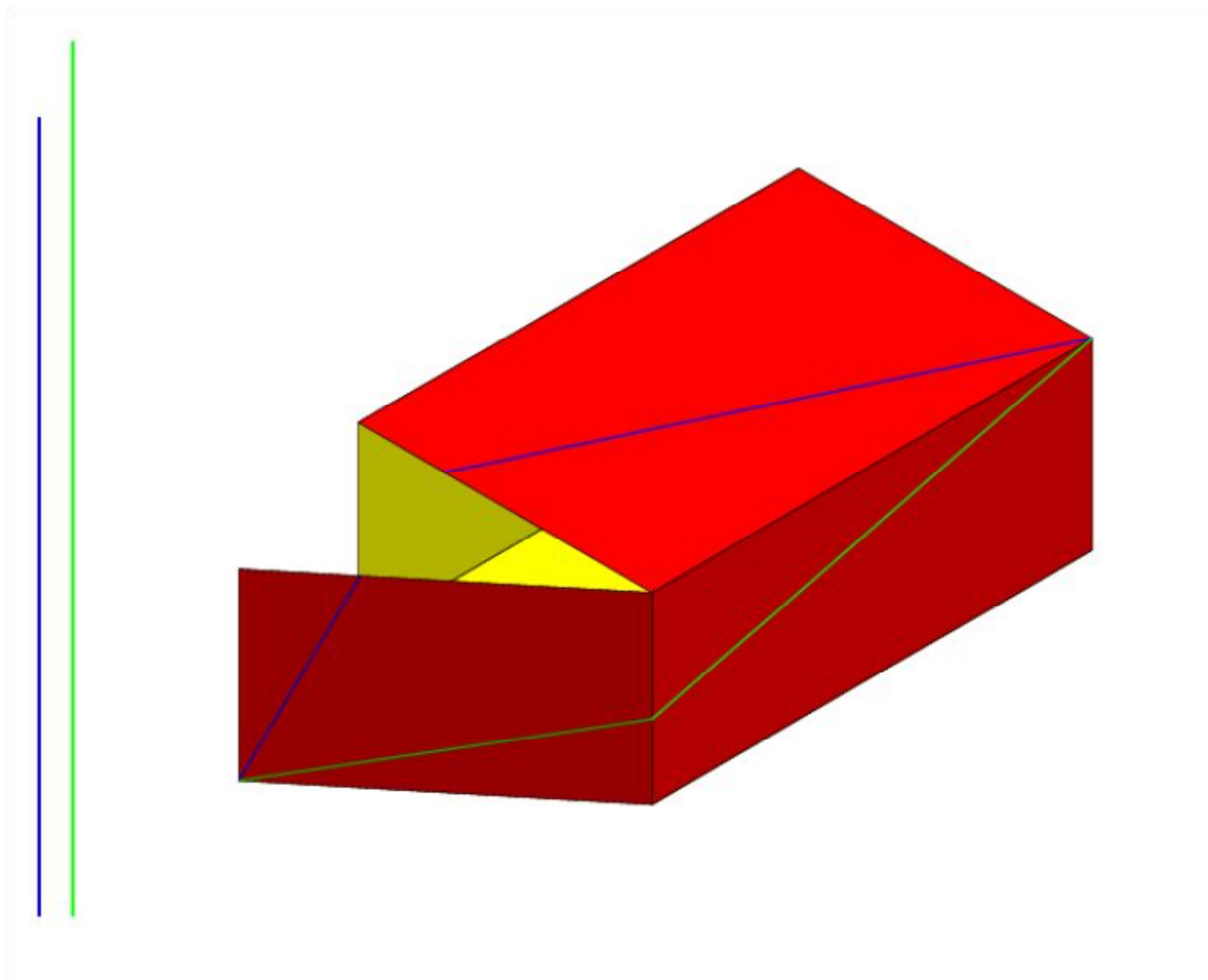

# La fourmi sur la caisse

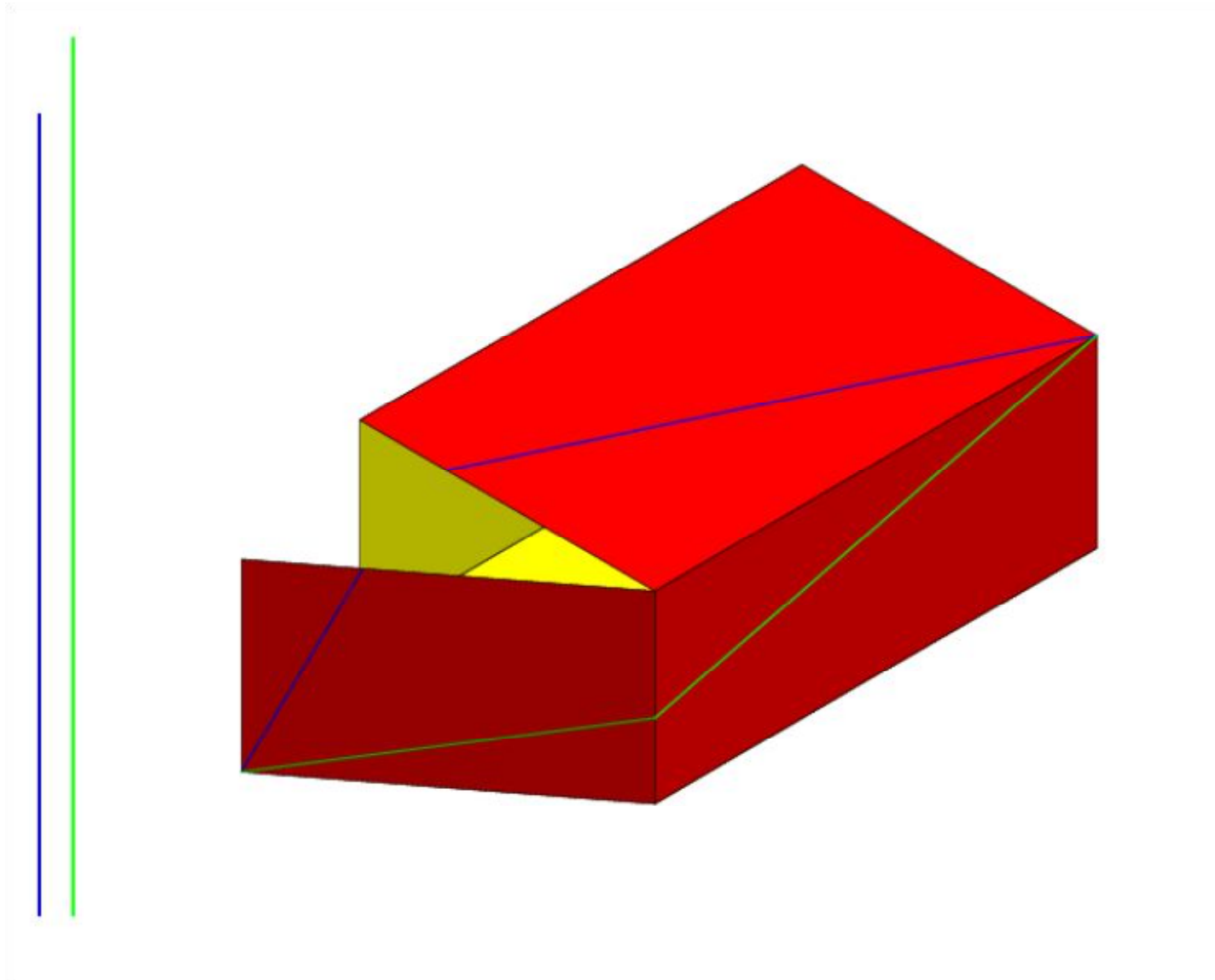

# La fourmi sur la caisse

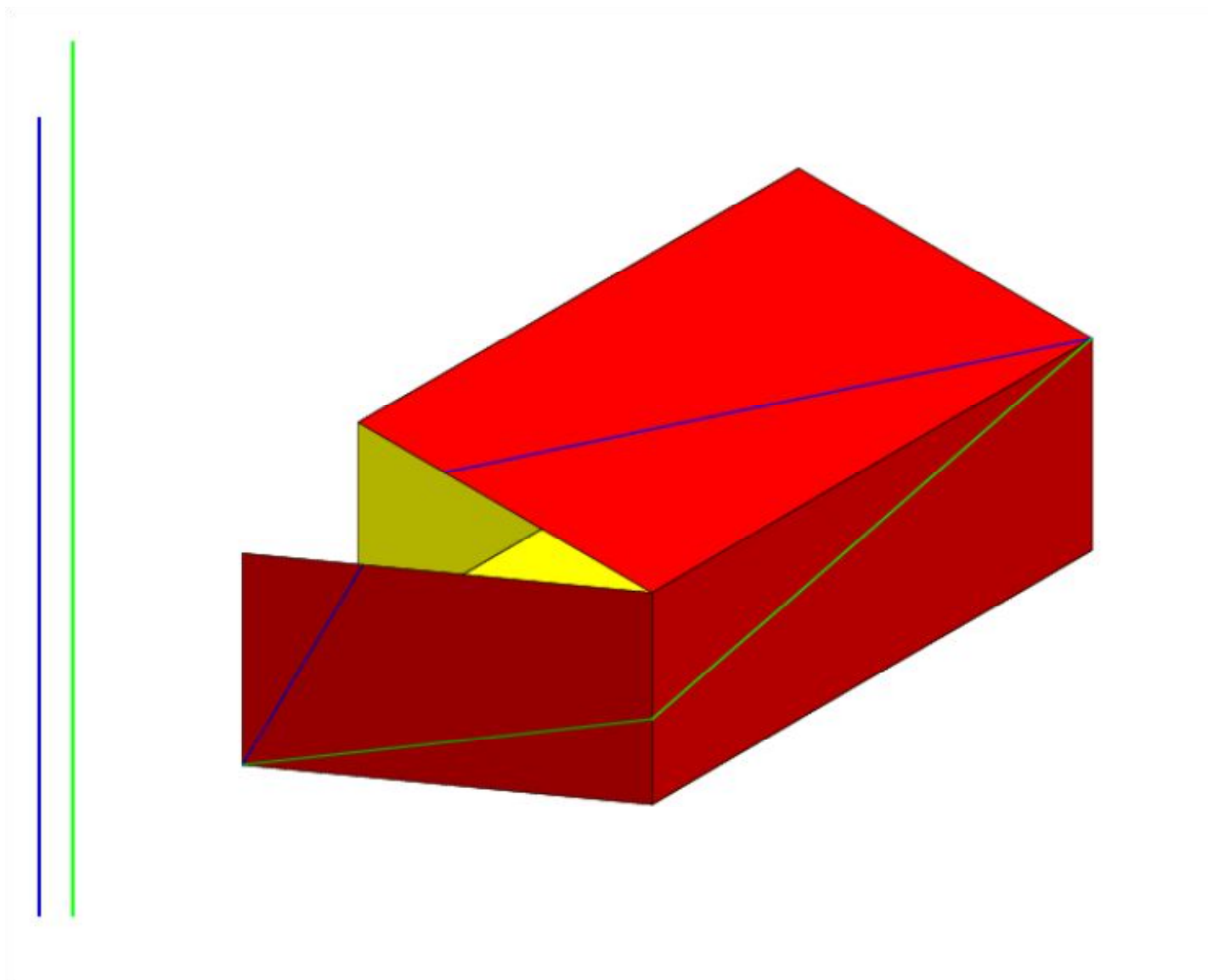

# La fourmi sur la caisse

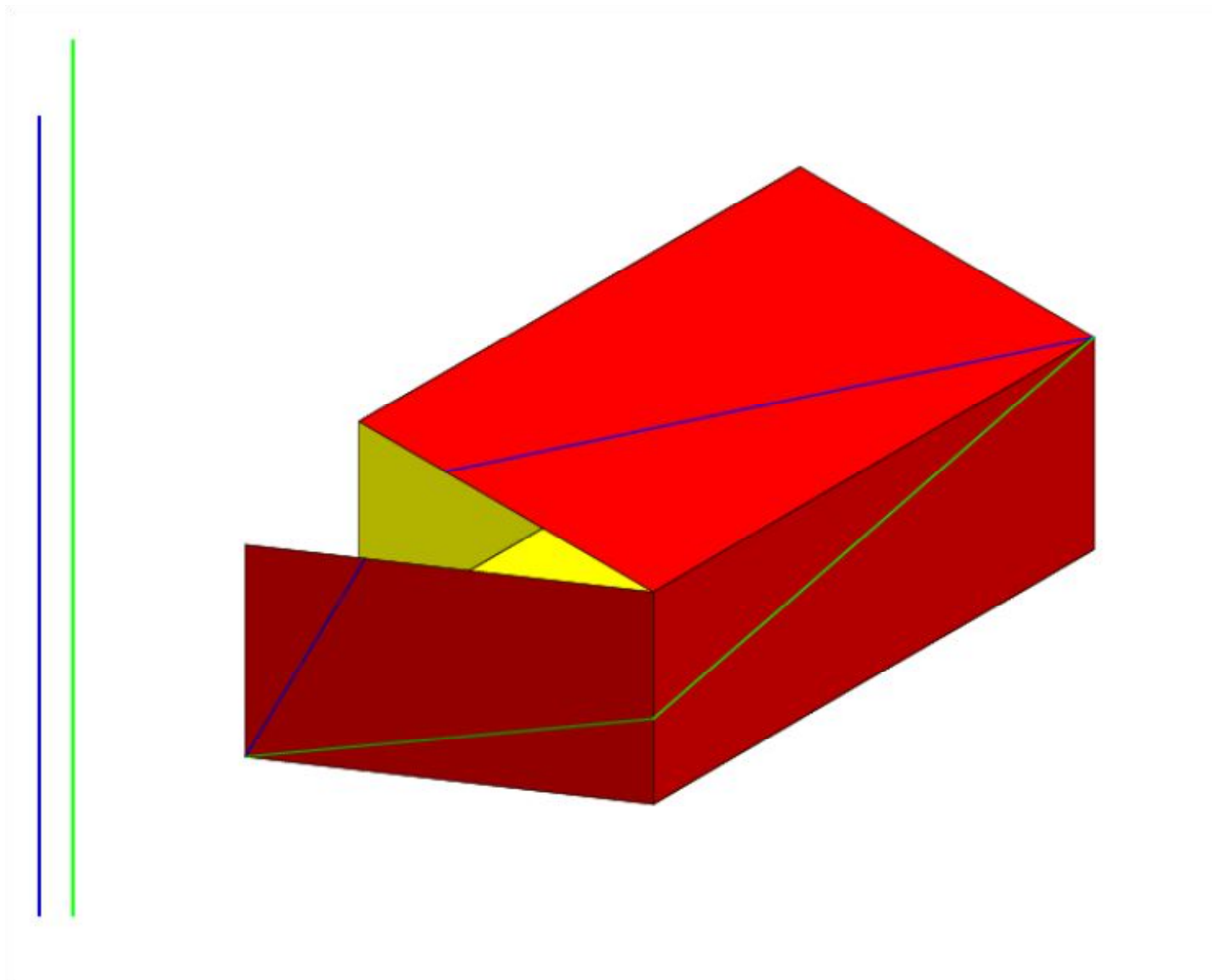

# La fourmi sur la caisse

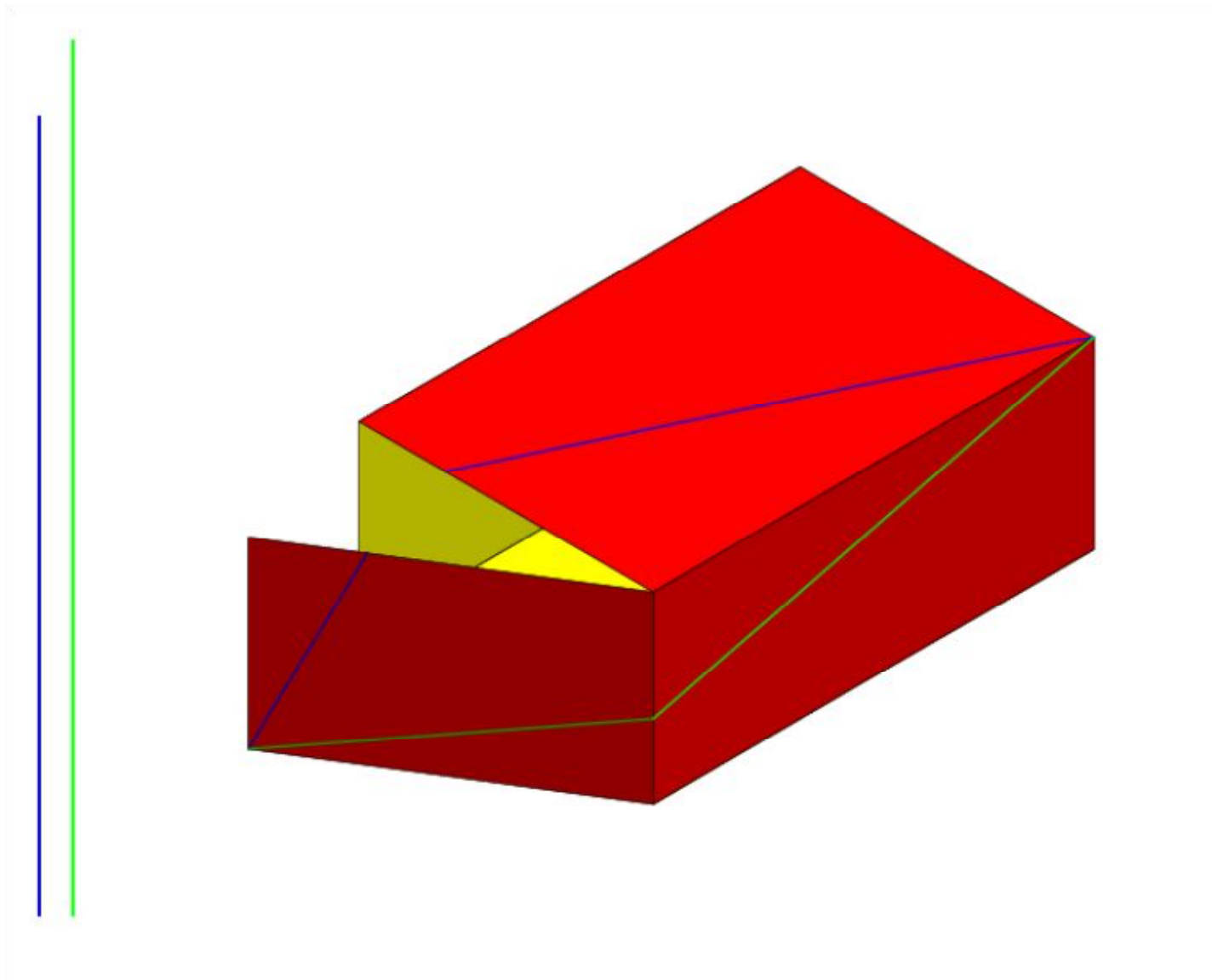

# La fourmi sur la caisse

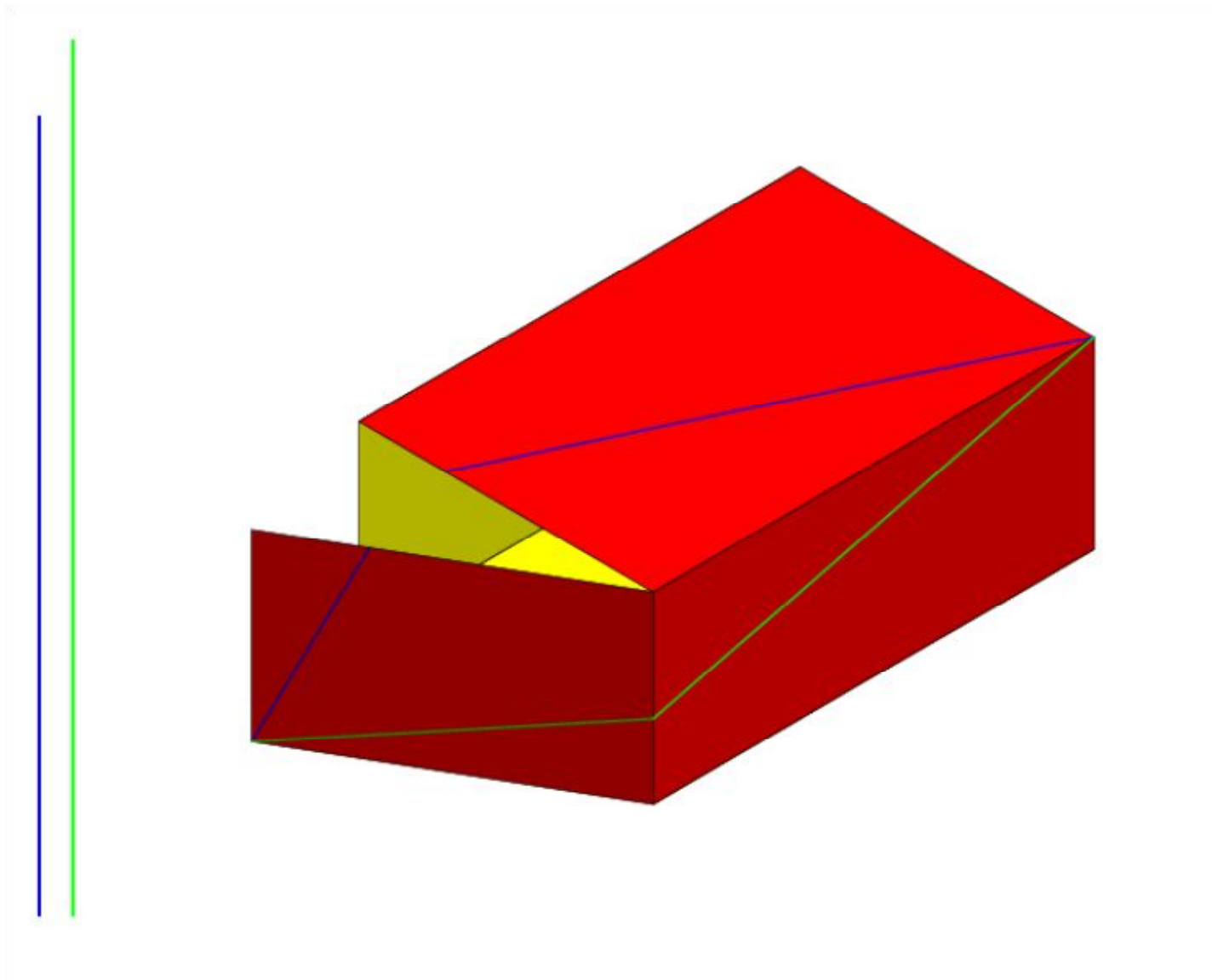



# La fourmi sur la caisse

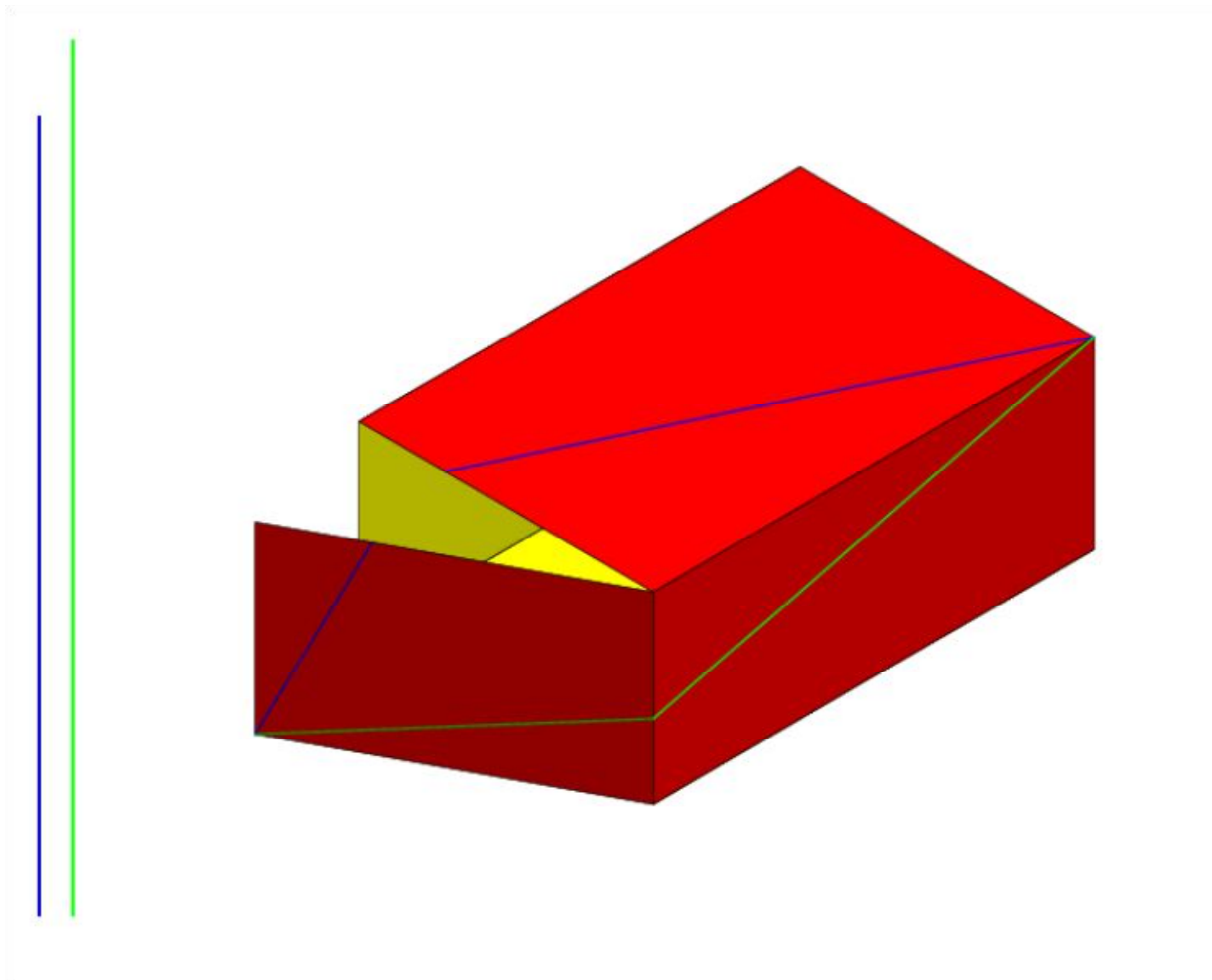

# La fourmi sur la caisse

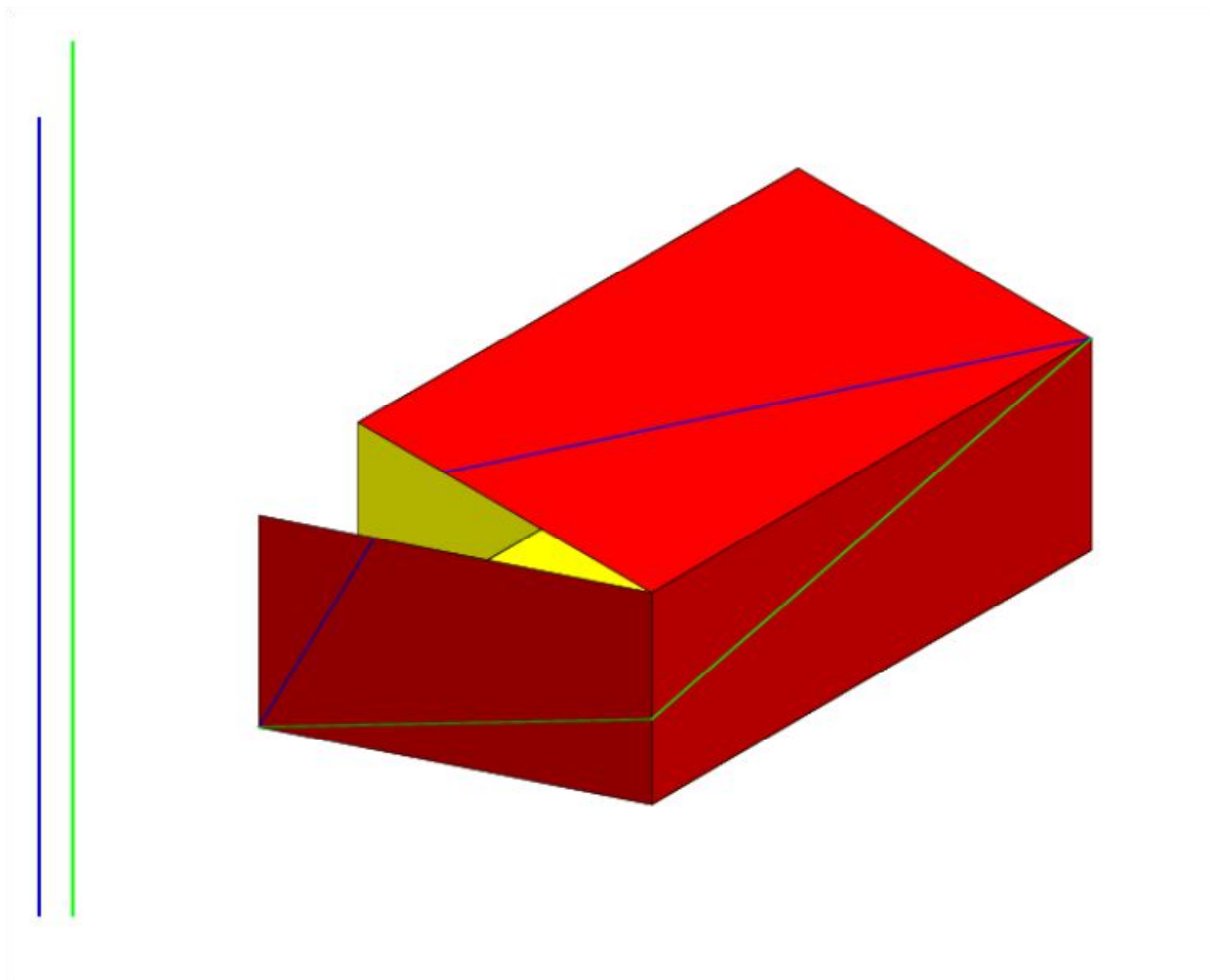

# La fourmi sur la caisse

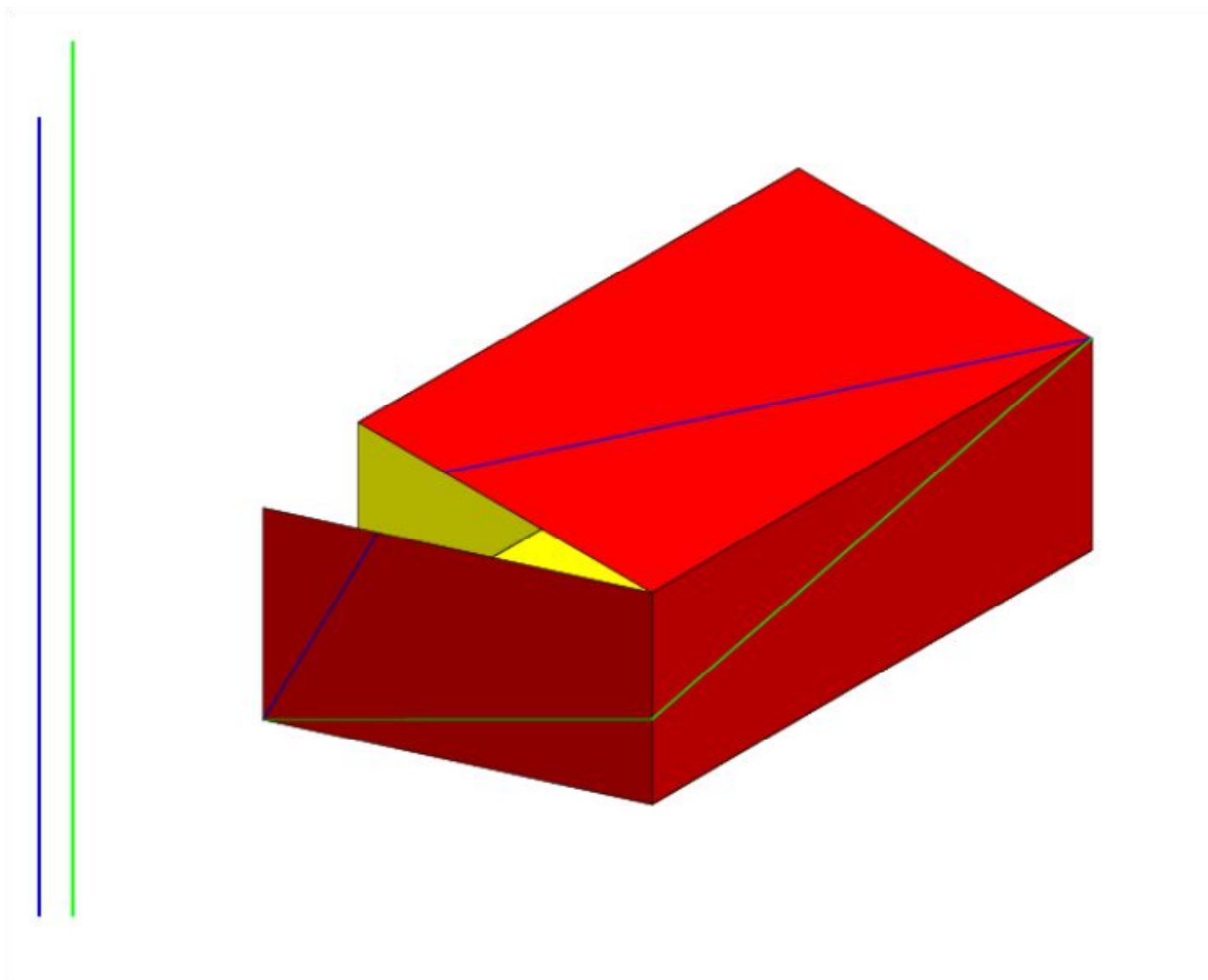

# La fourmi sur la caisse

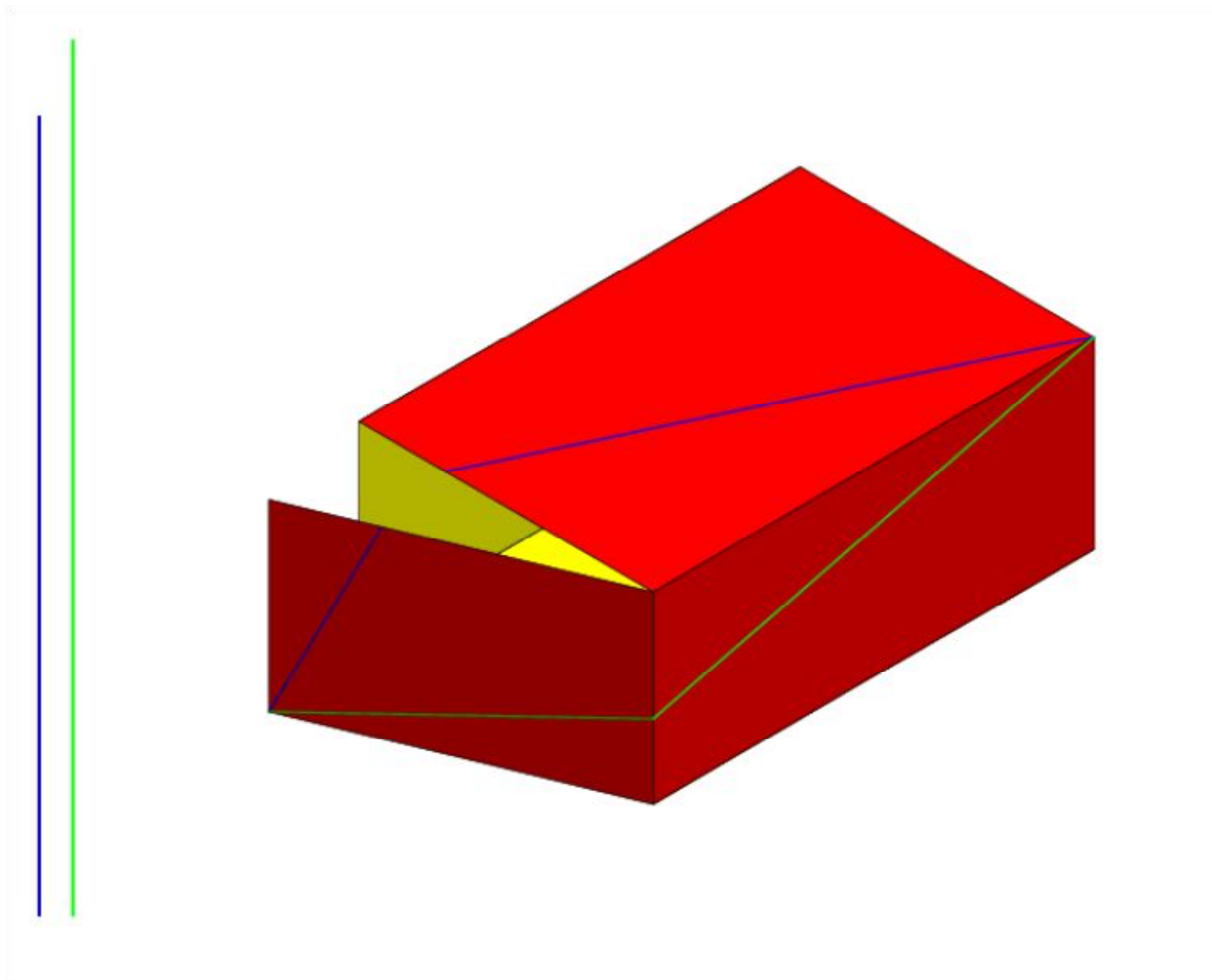

# La fourmi sur la caisse

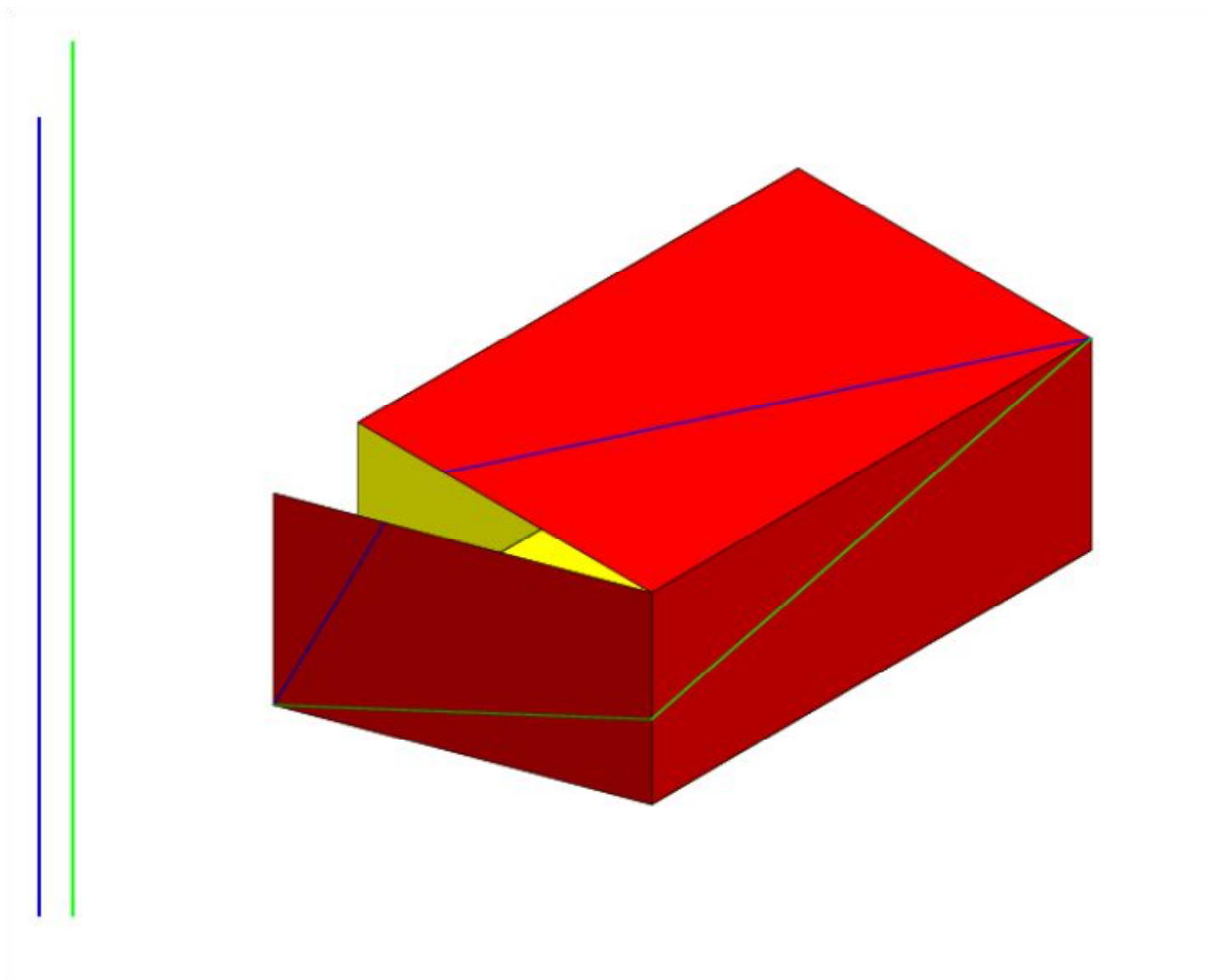

# La fourmi sur la caisse

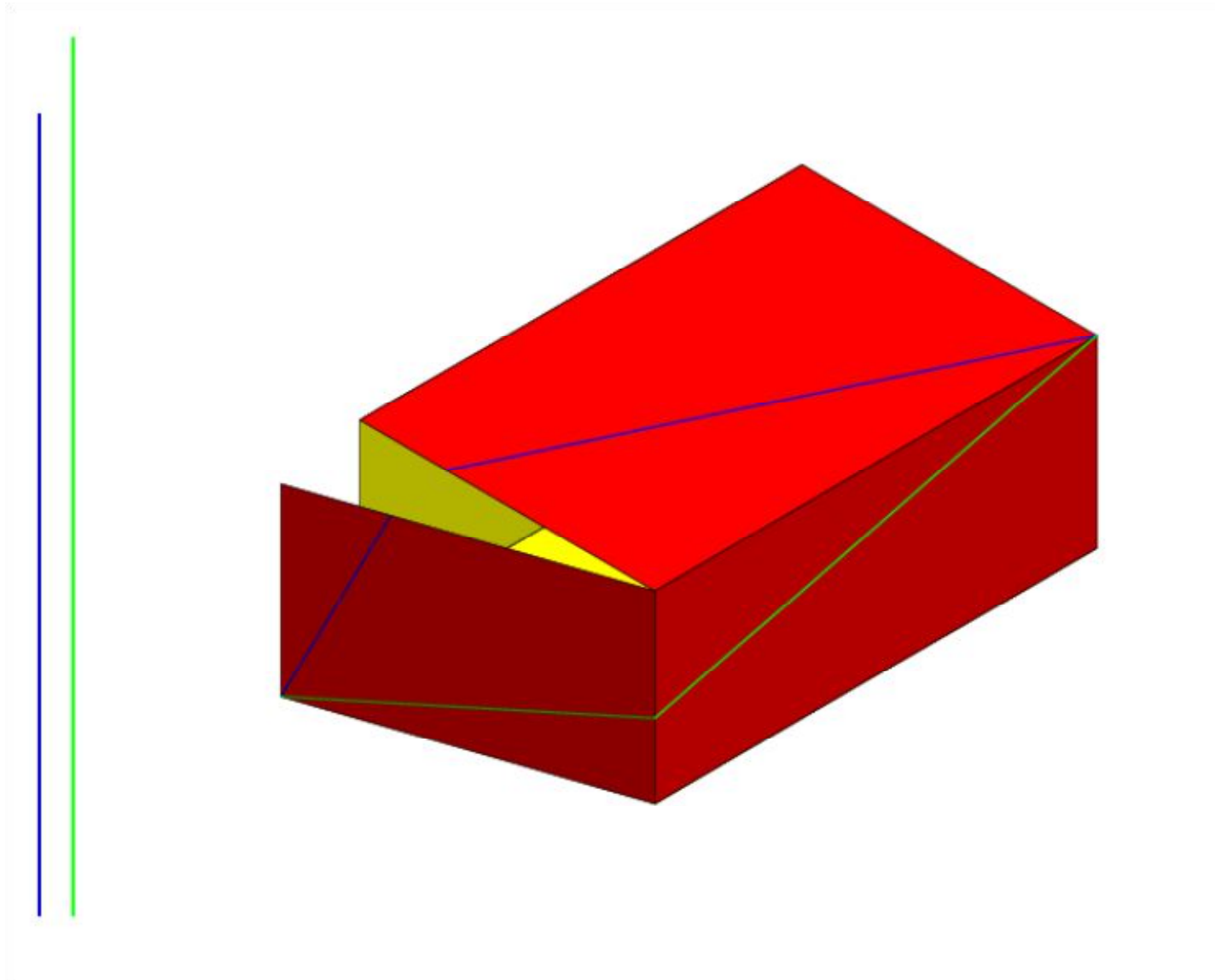

# La fourmi sur la caisse

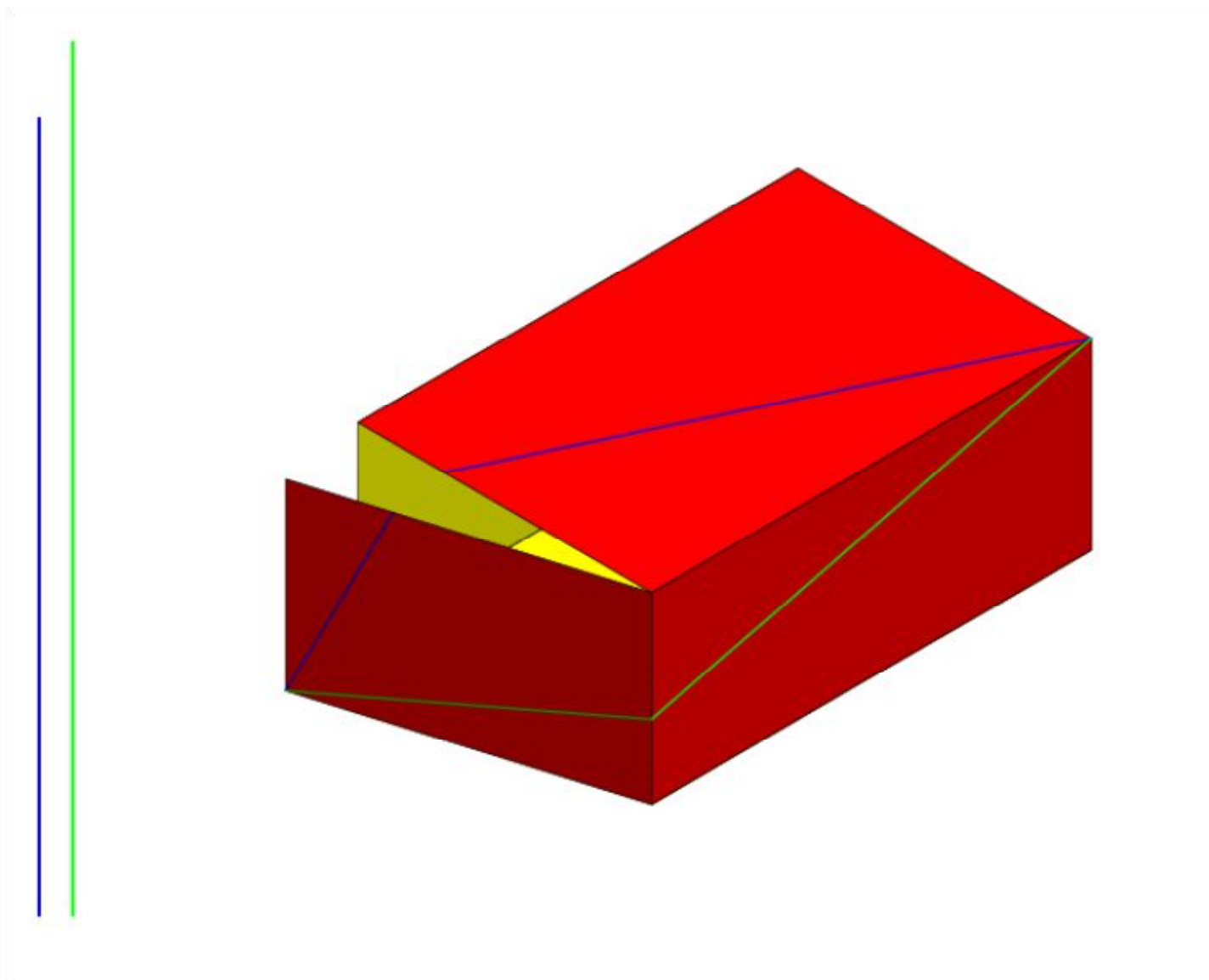

# La fourmi sur la caisse

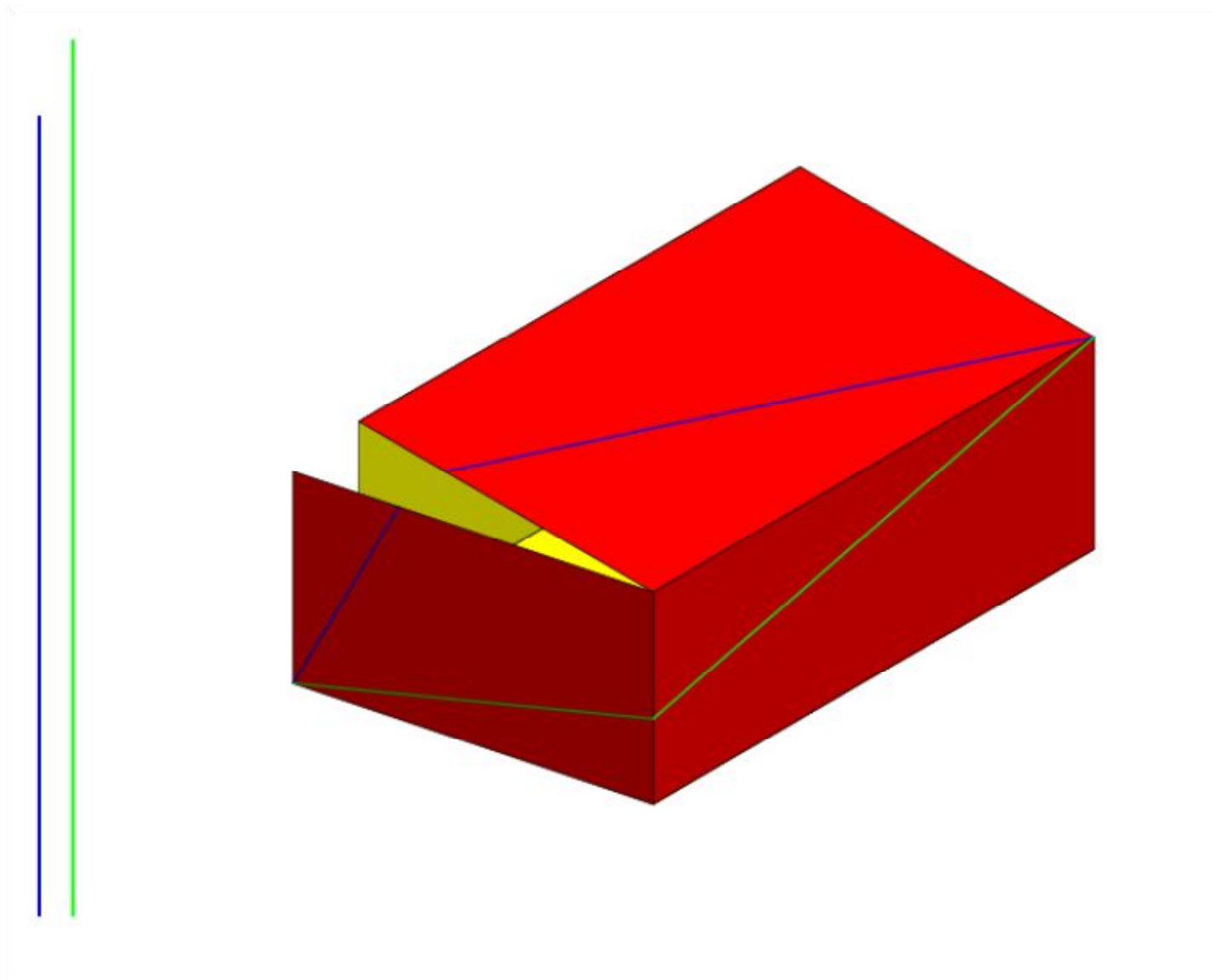



# La fourmi sur la caisse

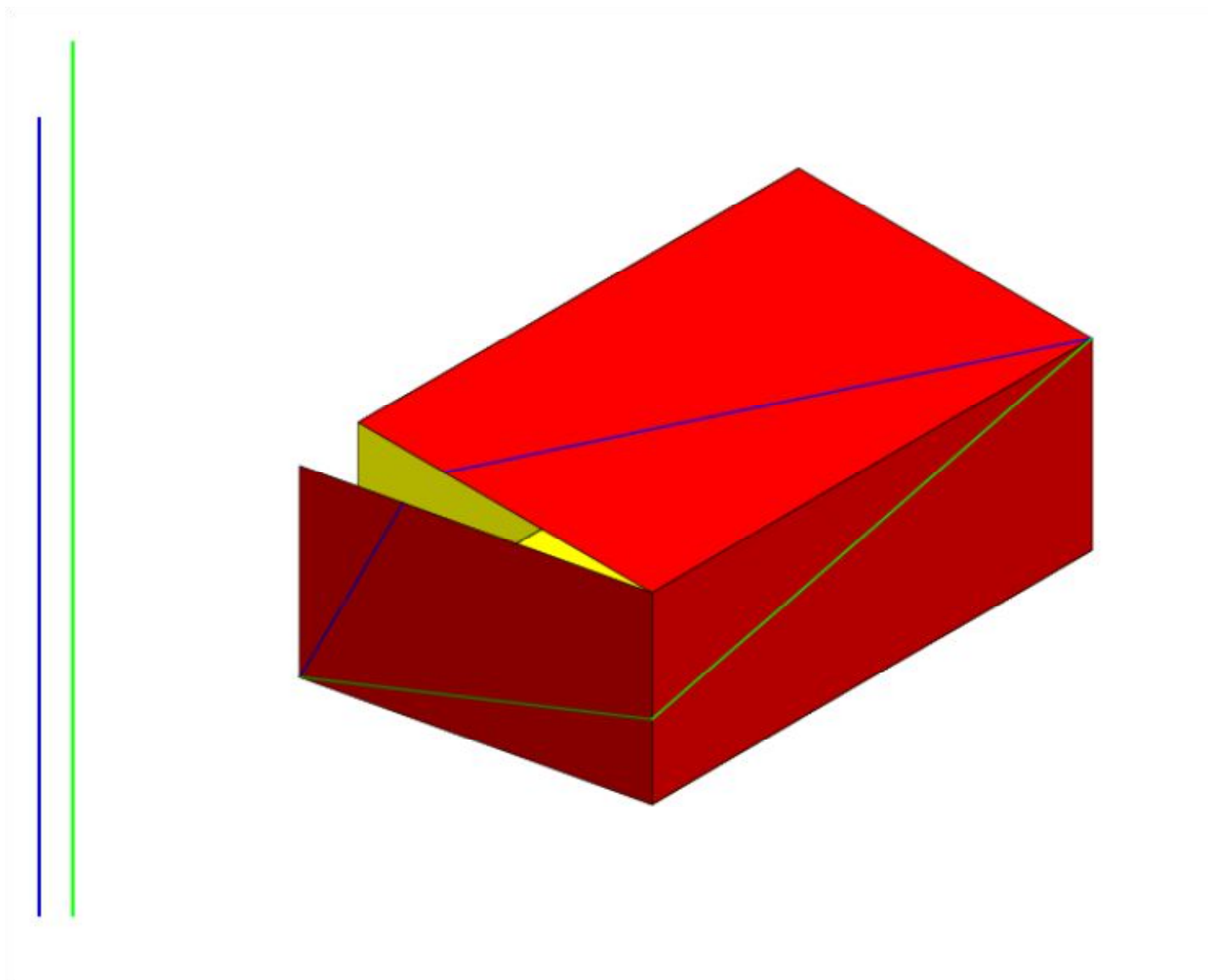

# La fourmi sur la caisse

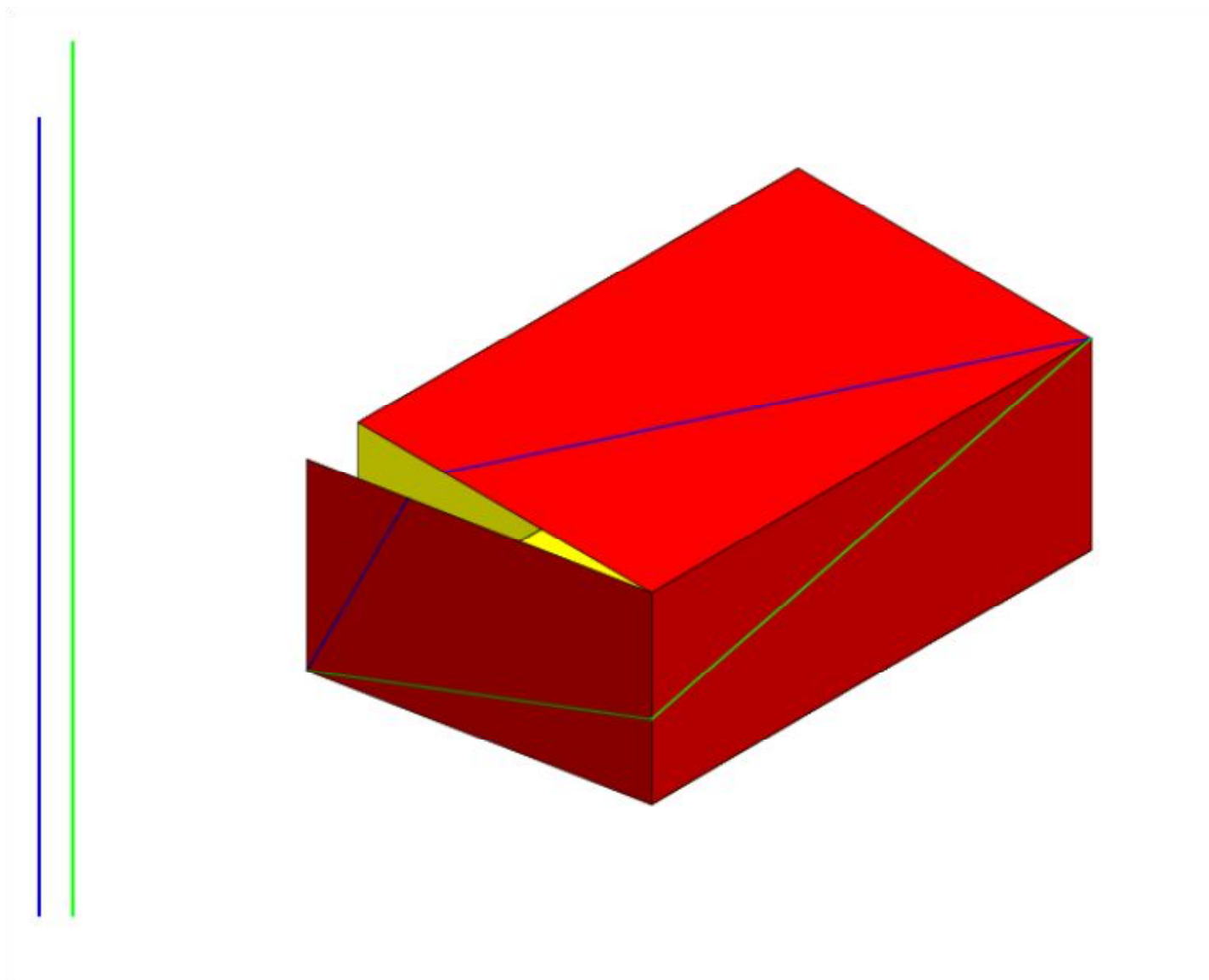

# La fourmi sur la caisse

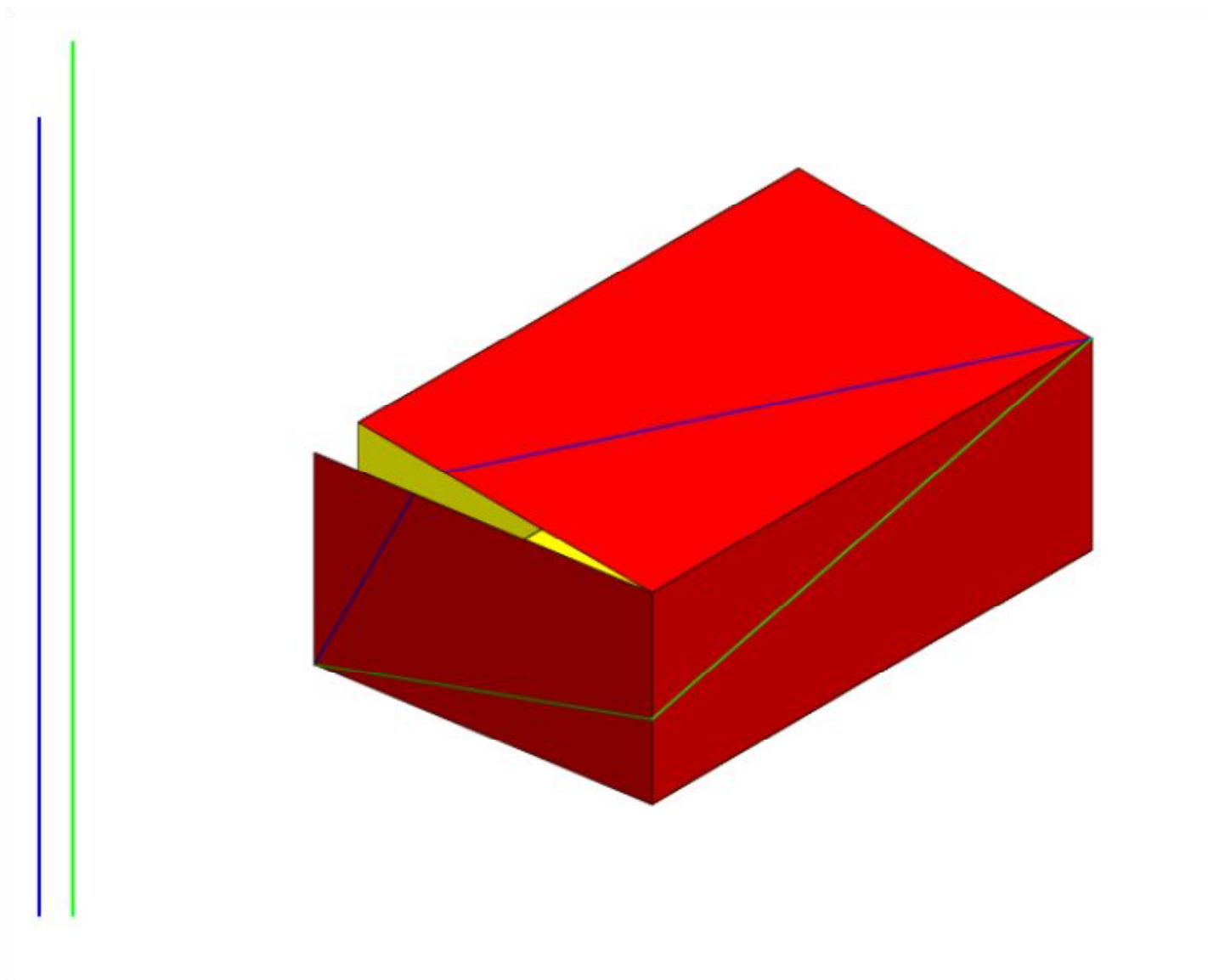

# La fourmi sur la caisse

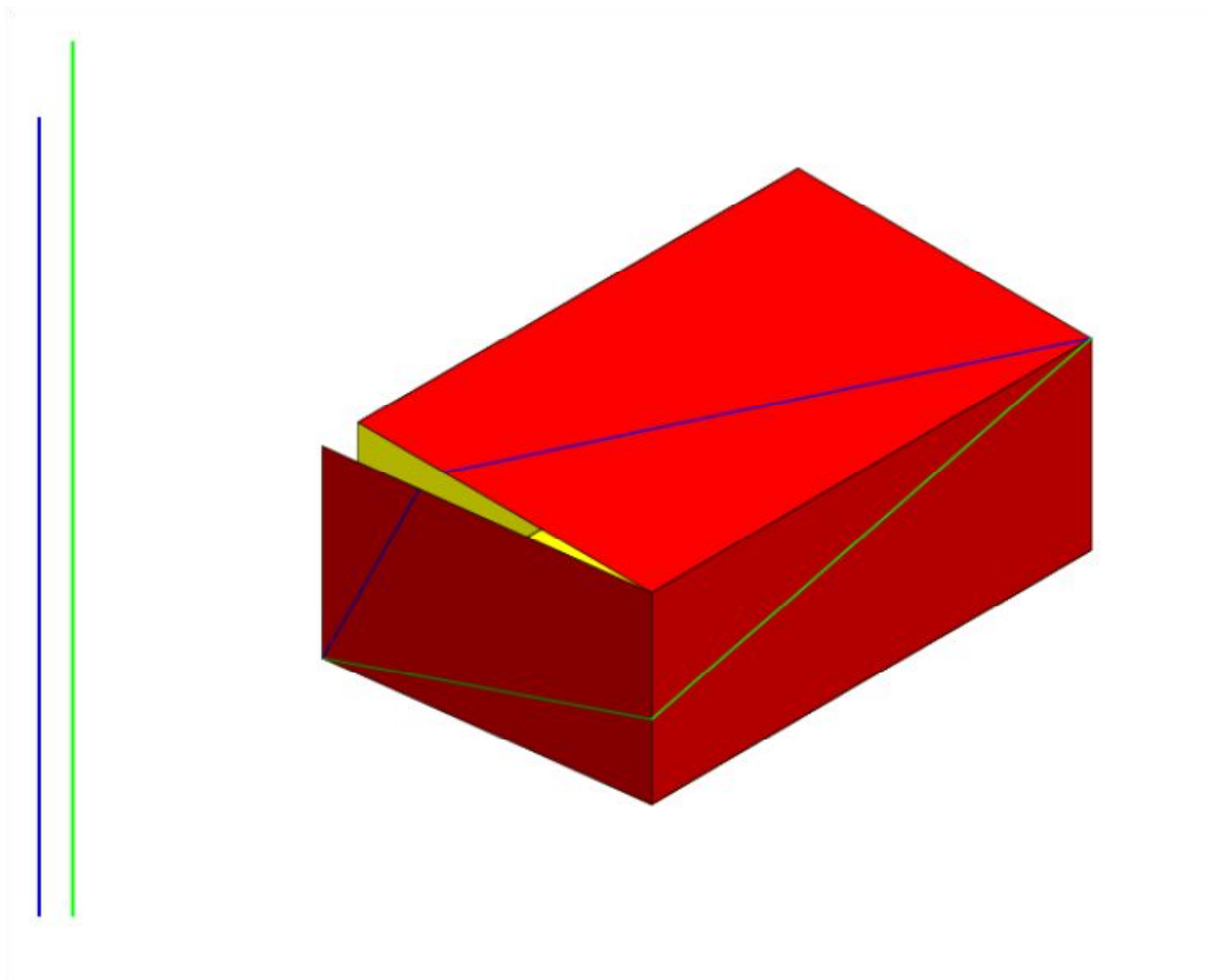

# La fourmi sur la caisse

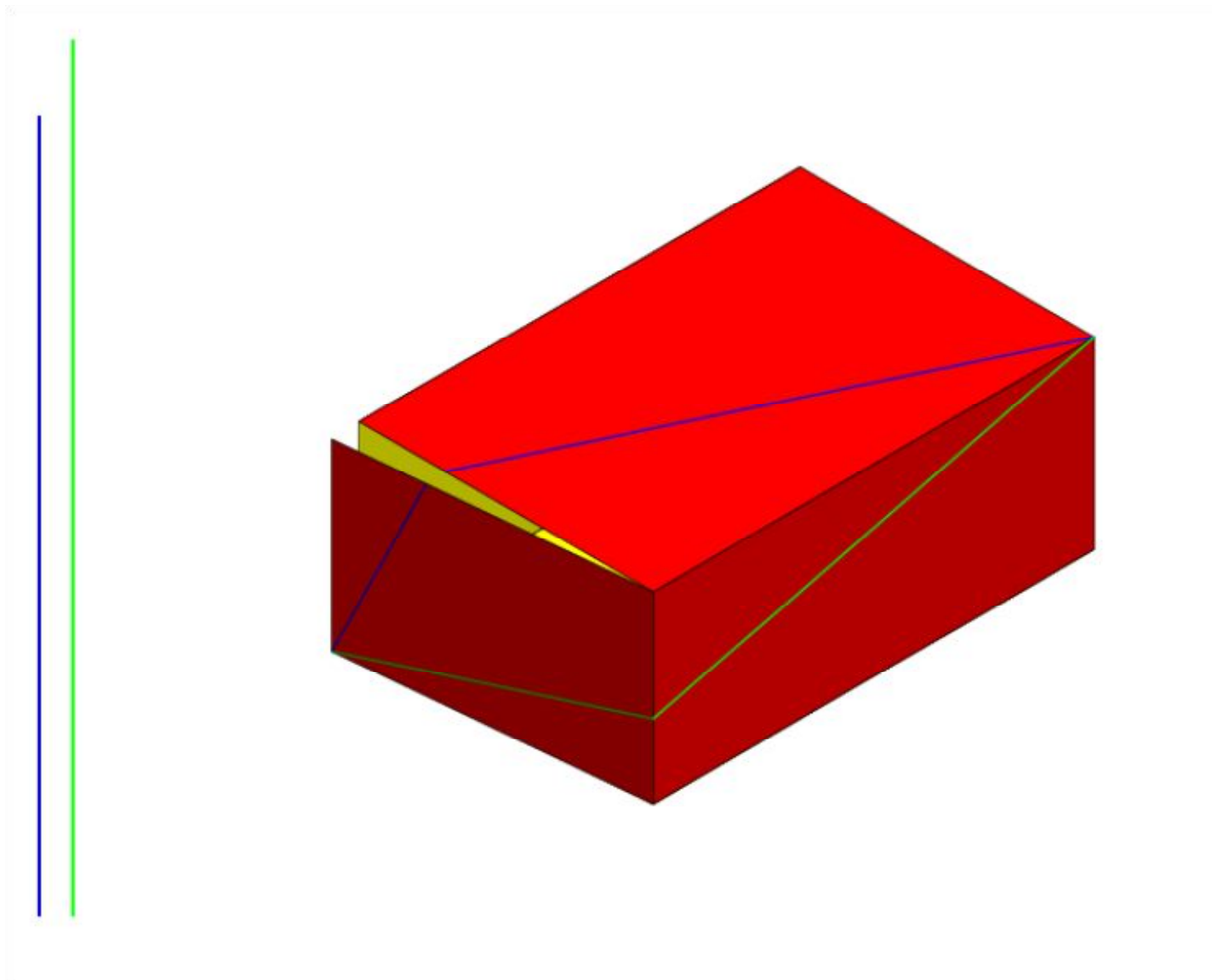

# La fourmi sur la caisse

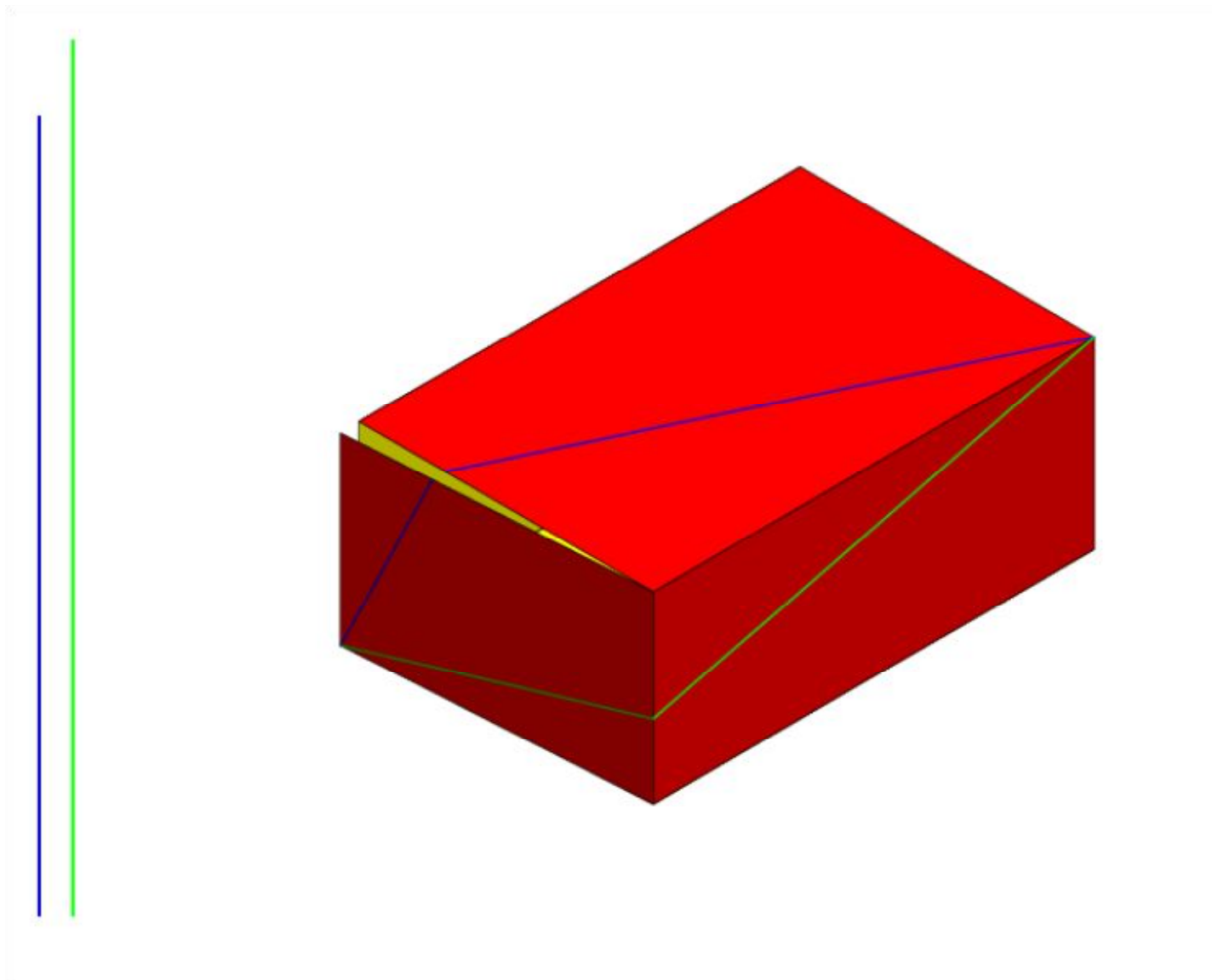

# La fourmi sur la caisse

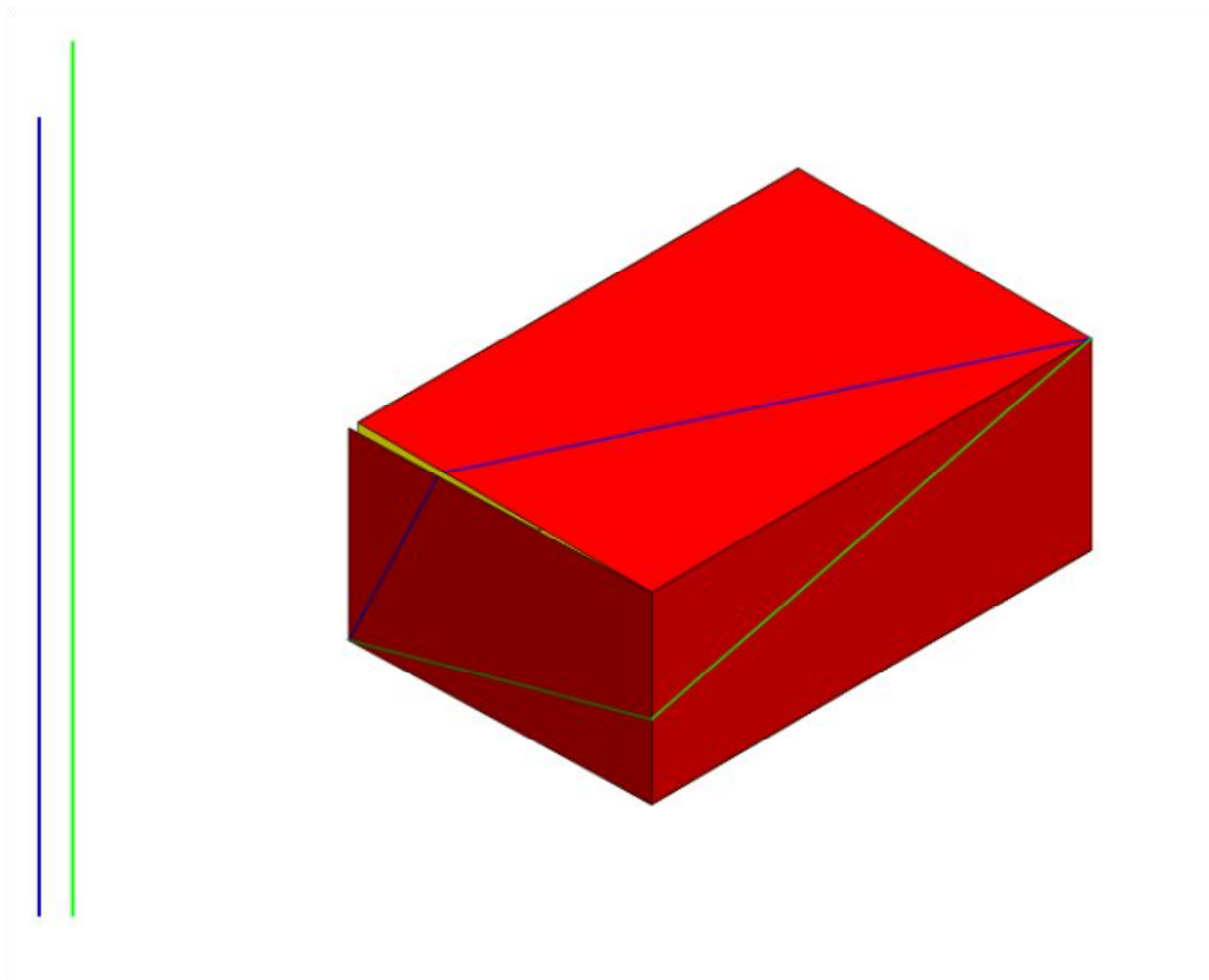

# La fourmi sur la caisse

